

E	MAJ suite remarques client	21/03/2017	ELS	Y.C.	CTP ENV.
D	TQC	20/02/2017	ELS	Y.C.	CTP ENV.
C	MAJ suite remarques client	09/02/2017	ELS	Y.C.	CTP ENV.
B	Deplacement de AU	09/02/2017	AF	YC	CTP ENV.
A	Création du dossier	23/01/2017	A.F.	Y.C.	CTP ENV.
INDICE	MODIFICATION	DATE	DESSINE	VERIFIE	APPROUVE



E.L.S.

ALLEE ANDRE MARIE AMPERE
42500 LE CHAMBON FEUGEROLLES

TEL : 04 77 40 15 30

FAX : 04 77 40 15 39

CTP ENVIRONNEMENT

12 Avenue Henri Schneider
69330 JONAGE

TEL : 04 72 47 72 14

FAX : 04 72 47 01 13

OPTIFLOW 2

SCHEMA ELECTRIQUE

Page de garde

DOCUMENT N° : **ELS1701077**

1 / 28

CE DOCUMENT EST NOTRE PROPRIETE. IL EST REMIS A TITRE CONFIDENTIEL.
IL NE DOIT PAS ETRE REPRODUIT OU COMMUNIQUE A DES TIERS SANS NOTRE AUTORISATION ECRITE

Document réalisé avec SEE, logiciel du groupe IGE+XAO tel. (33) (0)5 62 74 36 36

N° FOLIO	DESIGNATION	MODIFICATIONS								
		1	2	3	4	5	6	7	8	9
1	Page de garde	A	B	C	D	E				
2	Liste des folios	A	B	C	D	E				
09	PARAMETRES VARIATEURS	E								
10	PLAN D'EQUIPEMENT	A	B	C	D	E				
11	PLAN D'EQUIPEMENT FACADE	A	B	C	D	E				
12	ALIMENTATION	A	C	D	E					
14	AGITATEURS	A	C	D	E					
15	POMPE INJECTION ACIDE	A	C	D	E					
16	DOSEUR A Poudre	A	C	D	E					
17	DISTRIBUTION 230V	A	C	D	E					
18	POMPE DOSEUSE INHIBITEUR DE CORROSION	A	C	D	E					
19	ARRET D'URGENCE	A	C	D	E					
20	IHM + MODEM	A	C	D	E					
21	IFM AY1020	A	C	D	E					
22	API1 - Configuration Automate	A	C	D	E					
23	Base CPU - Raccordement	A	C	D	E					
24	DI1 - Module d'entrées	A	C	D	E					
25	DI1 - Module d'entrées	A	C	D	E					
26	DO1 - Module de sorties	A	C	D	E					
27	DO1 - Module de sorties	A	C	D	E					
28	AIO1 - Module d'entrées/sorties	A	C	D	E					
29	AIO1 - Module d'entrées/sorties	C	D	E						
30	AIO1 - Module d'entrées/sorties	A	C	D	E					
31	AIO1 - Module d'entrées/sorties	C	D	E						
40	Bornier : +COFFRET-X1 1/2	B	C	D	E					
41	Bornier : +COFFRET-X1 2/2	B	C	D	E					
45	Nomenclature matériel	A	B	C	D	E				
46	Nomenclature matériel	A	B	C	D	E				

N° FOLIO	DESIGNATION	MODIFICATIONS								
		1	2	3	4	5	6	7	8	9

+ COFFRET



E.L.S.
ALLEE ANDRE MARIE AMPERE
42500 LE CHAMBON FEUGEROLLES

E	21/03/2017	MAJ suite remarques client	ELS
D	20/02/2017	TQC	ELS
C	09/02/2017	MAJ suite remarques client	ELS
B	09/02/2017	Deplacement de AU	AF
INDICE	DATE	MODIFICATION	DES.

CTP ENVIRONNEMENT
Document n° : **ELS1701077**

OPTIFLOW 2
Liste des folios

ACS310	Equipements	
	PD2200	VDA2700
Paramètres variateur	Menu complet	Menu complet
1611	Menu complet	Menu complet
9901	Français	Français
9902	Standard ABB	Standard ABB
9904	Scalaire	Scalaire
9905	400 V	400 V
9906	4,66 A	1,52
9907	50 Hz	50 Hz
9908	1490 rpm	1375 rpm
9909	2,2 kW	0,55 kW
9914	Non	
9802	STD MODBUS	STD MODBUS
1601	NON SELEC	NON SELEC
1604	COMM	COMM
5302	10	20
5303	192	192
5304	8N1	8N1
5305	ABB DRIVE FULL	ABB DRIVE FULL
1001	COMM	COMM
1102	COMM	COMM
1103	COMM	COMM
1201	NON SELECT	NON SELECT
2003		
2007	0	0
2102	RAMPE	RAMPE
2201	NON SELECT	NON SELECT
5309	RESET	RESET

+ COFFRET



E.L.S.
 ALLEE ANDRE MARIE AMPERE
 42500 LE CHAMON FEUGEROLLES

E	21/03/2017	MAJ suite remarques client	ELS
INDICE	DATE	MODIFICATION	DES.

CTP ENVIRONNEMENT
 Document n° : **ELS1701077**

OPTIFLOW 2
 PARAMETRES VARIATEURS

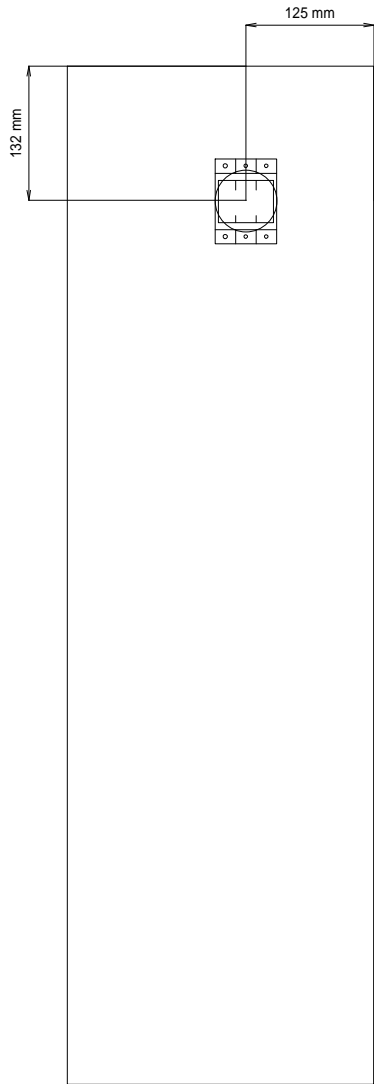

COTE DROIT

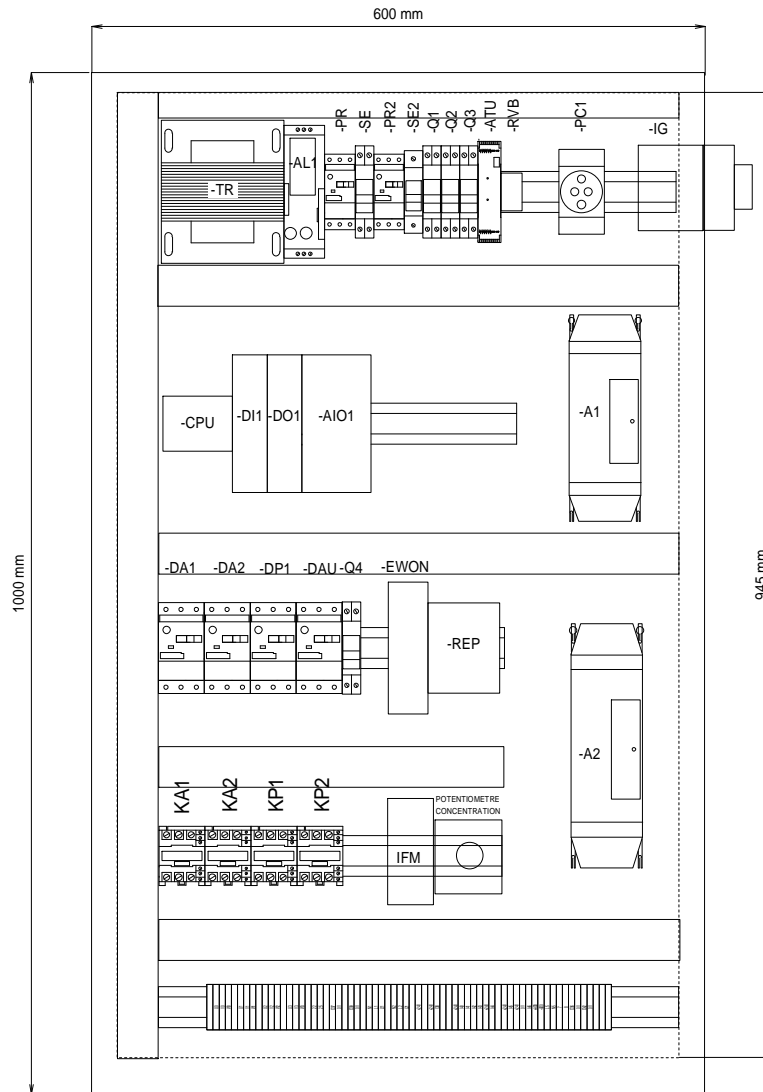

CHASSIS

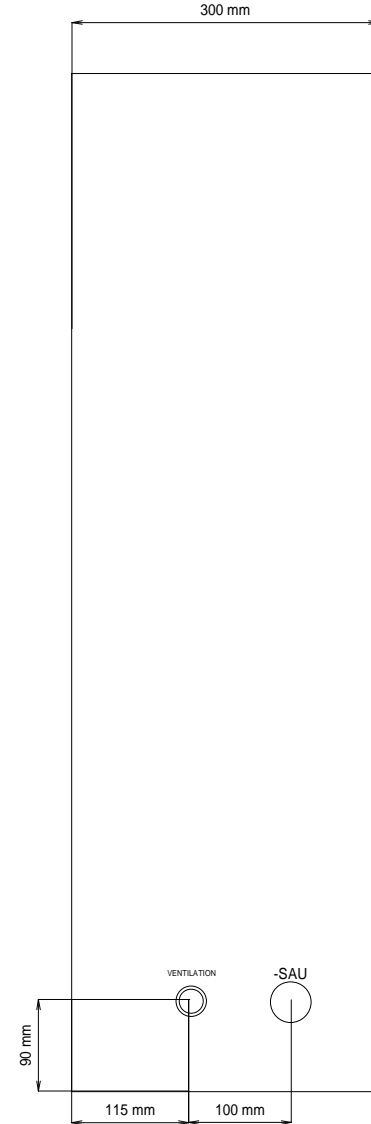

COTE GAUCHE

+ COFFRET



E.L.S.
ALLEE ANDRE MARIE AMPERE
42500 LE CHAMBON FEUGEROLLES

E	21/03/2017	MAJ suite remarques client	ELS
D	20/02/2017	TQC	ELS
C	09/02/2017	MAJ suite remarques client	ELS
B	09/02/2017	Deplacement de AU	AF
INDICE	DATE	MODIFICATION	DES.

CTP ENVIRONNEMENT
Document n° : **ELS1701077**

OPTIFLOW 2
PLAN D'EQUIPEMENT

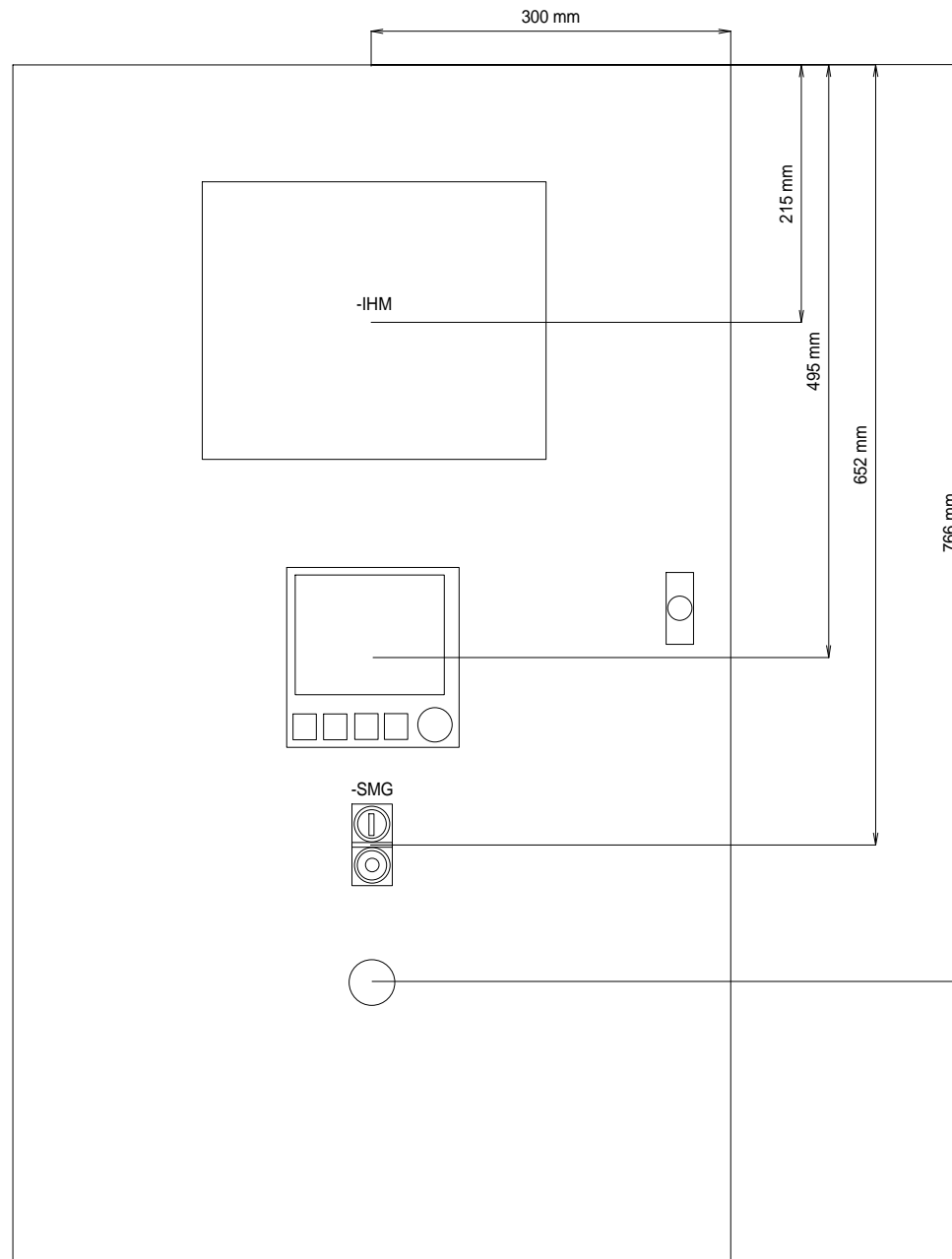

FACADE

+ COFFRET



E.L.S.
 ALLEE ANDRE MARIE AMPERE
 42500 LE CHAMBON FEUGEROLLES

E	21/03/2017	MAJ suite remarques client	ELS
D	20/02/2017	TQC	ELS
C	09/02/2017	MAJ suite remarques client	ELS
B	09/02/2017	Deplacement de AU	AF
INDICE	DATE	MODIFICATION	DES.

CTP ENVIRONNEMENT

Document n° : **ELS1701077**

OPTIFLOW 2
 PLAN D'EQUIPEMENT FACADE

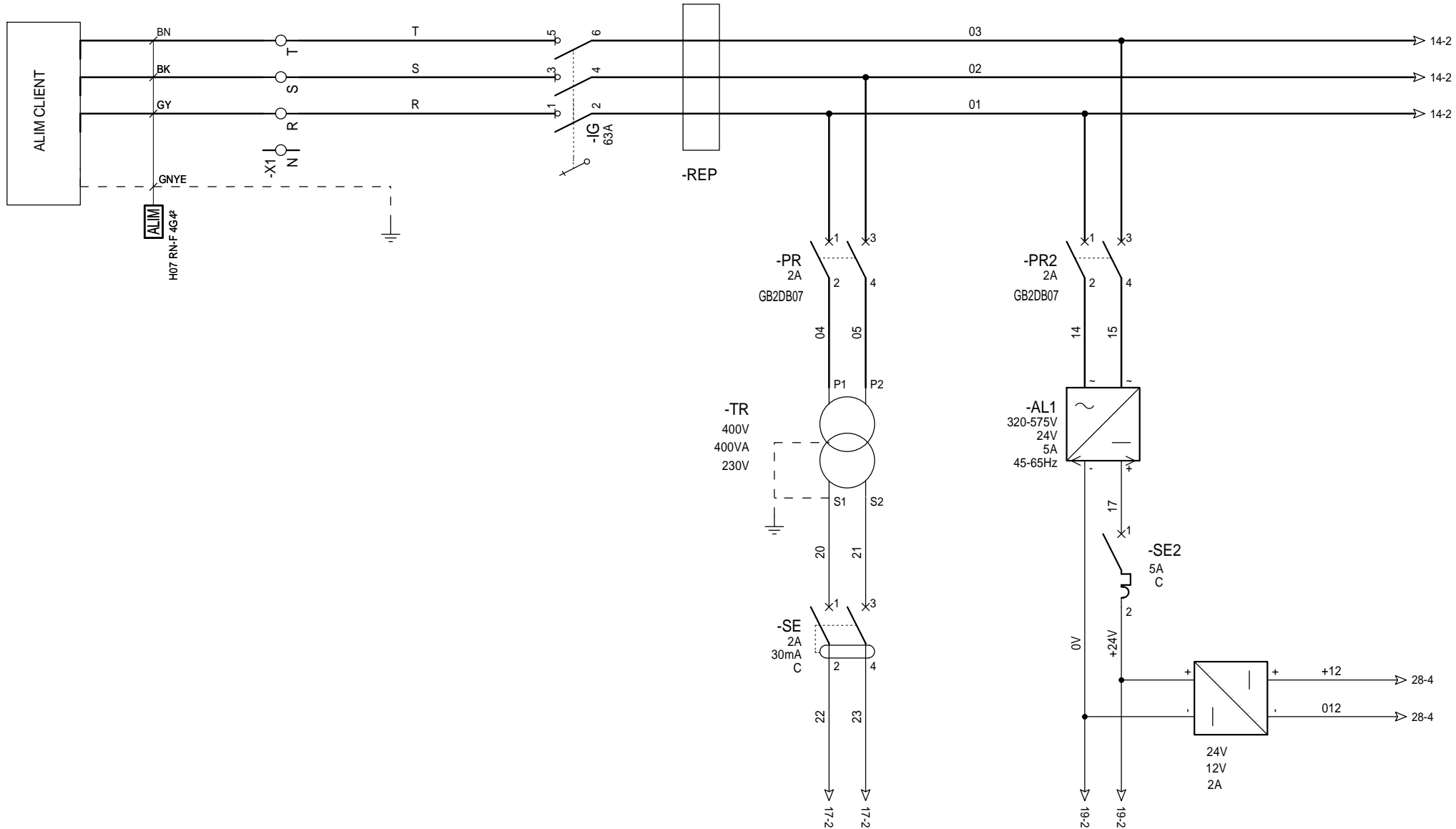

-COFFRET

+ COFFRET



E.L.S.
 ALLEE ANDRE MARIE AMPERE
 42500 LE CHAMBON FEUGEROLLES

E	21/03/2017	MAJ suite remarques client	ELS
D	20/02/2017	TQC	ELS
C	09/02/2017	MAJ suite remarques client	ELS
A	23/01/2017	Création du dossier	A.F.
INDICE	DATE	MODIFICATION	DES.

CTP ENVIRONNEMENT
 Document n° : **ELS1701077**

OPTIFLOW 2
 ALIMANTATION

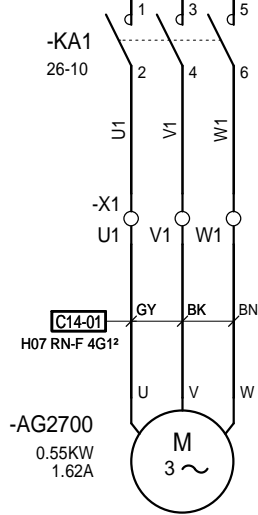
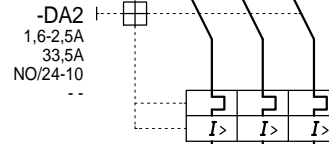
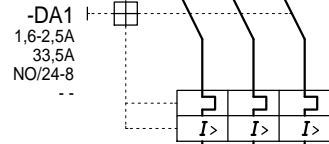
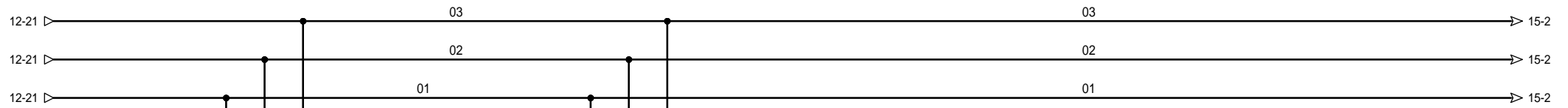

AGITATEUR 1

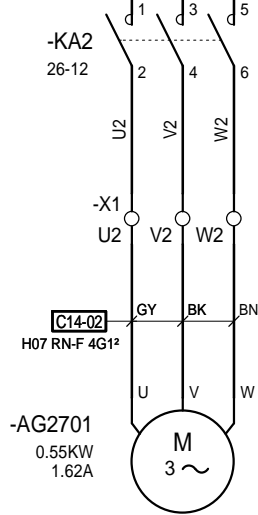

AGITATEUR 2

+ COFFRET



E.L.S.
ALLEE ANDRE MARIE AMPERE
42500 LE CHAMBON FEUGEROLLES

E	21/03/2017	MAJ suite remarques client	ELS
D	20/02/2017	TQC	ELS
C	09/02/2017	MAJ suite remarques client	ELS
A	23/01/2017	Création du dossier	A.F.
INDICE	DATE	MODIFICATION	DES.

CTP ENVIRONNEMENT

Document n° : **ELS1701077**

OPTIFLOW 2
AGITATEURS

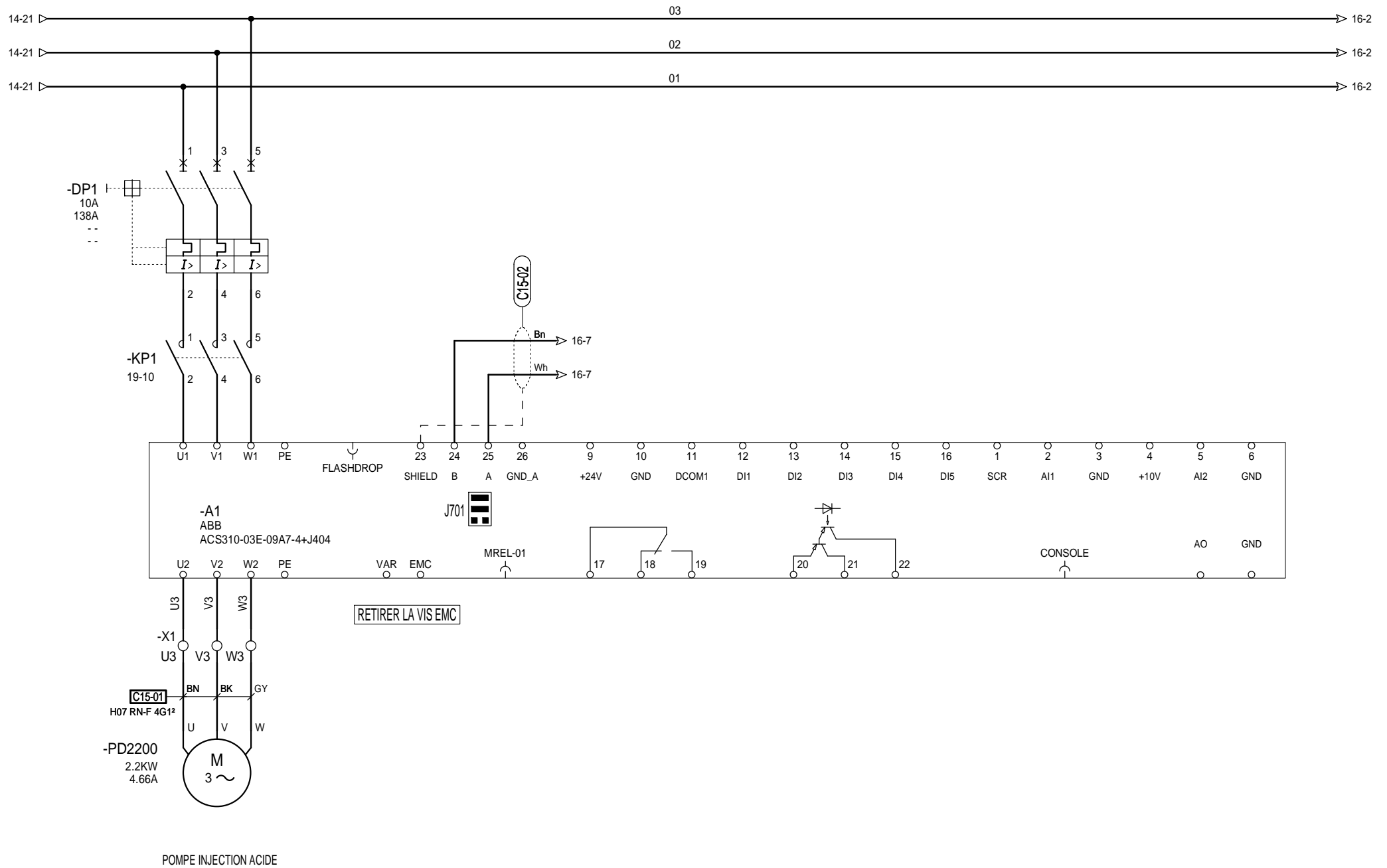

POMPE INJECTION ACIDE

+ COFFRET



E.L.S.
 ALLEE ANDRE MARIE AMPERE
 42500 LE CHAMBON FEUGEROLLES

E	21/03/2017	MAJ suite remarques client	ELS
D	20/02/2017	TQC	ELS
C	09/02/2017	MAJ suite remarques client	ELS
A	23/01/2017	Création du dossier	A.F.
INDICE	DATE	MODIFICATION	DES.

CTP ENVIRONNEMENT

Document n° : **ELS1701077**

OPTIFLOW 2
 POMPE INJECTION ACIDE

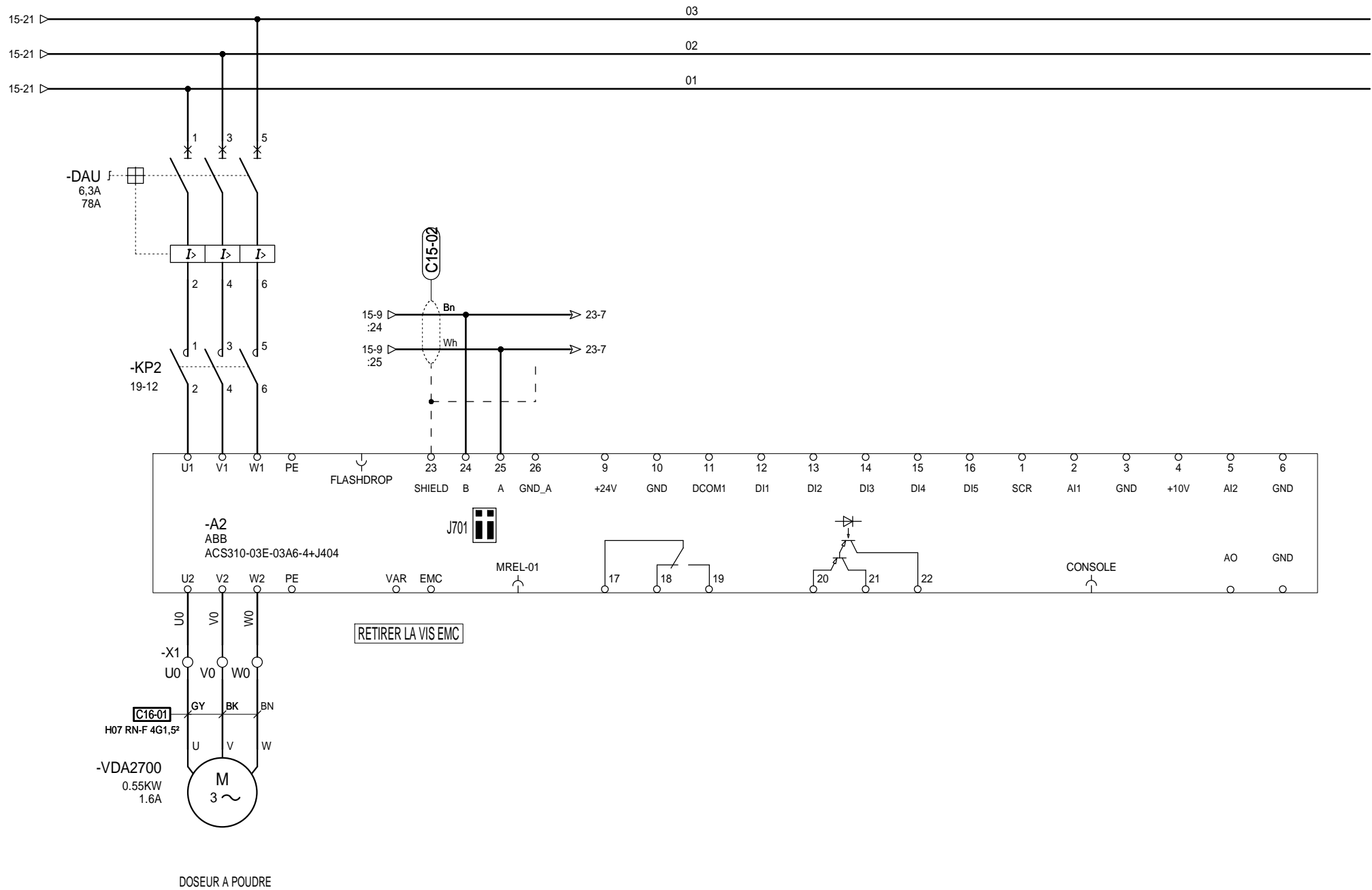

= + COFFRET



E.L.S.
 ALLEE ANDRE MARIE AMPERE
 42500 LE CHAMBON FEUGEROLLES

E	21/03/2017	MAJ suite remarques client	ELS
D	20/02/2017	TQC	ELS
C	09/02/2017	MAJ suite remarques client	ELS
A	23/01/2017	Création du dossier	A.F.
INDICE	DATE	MODIFICATION	DES.

CTP ENVIRONNEMENT
 Document n° : **ELS1701077**

OPTIFLOW 2
 DOSEUR A POUDRE

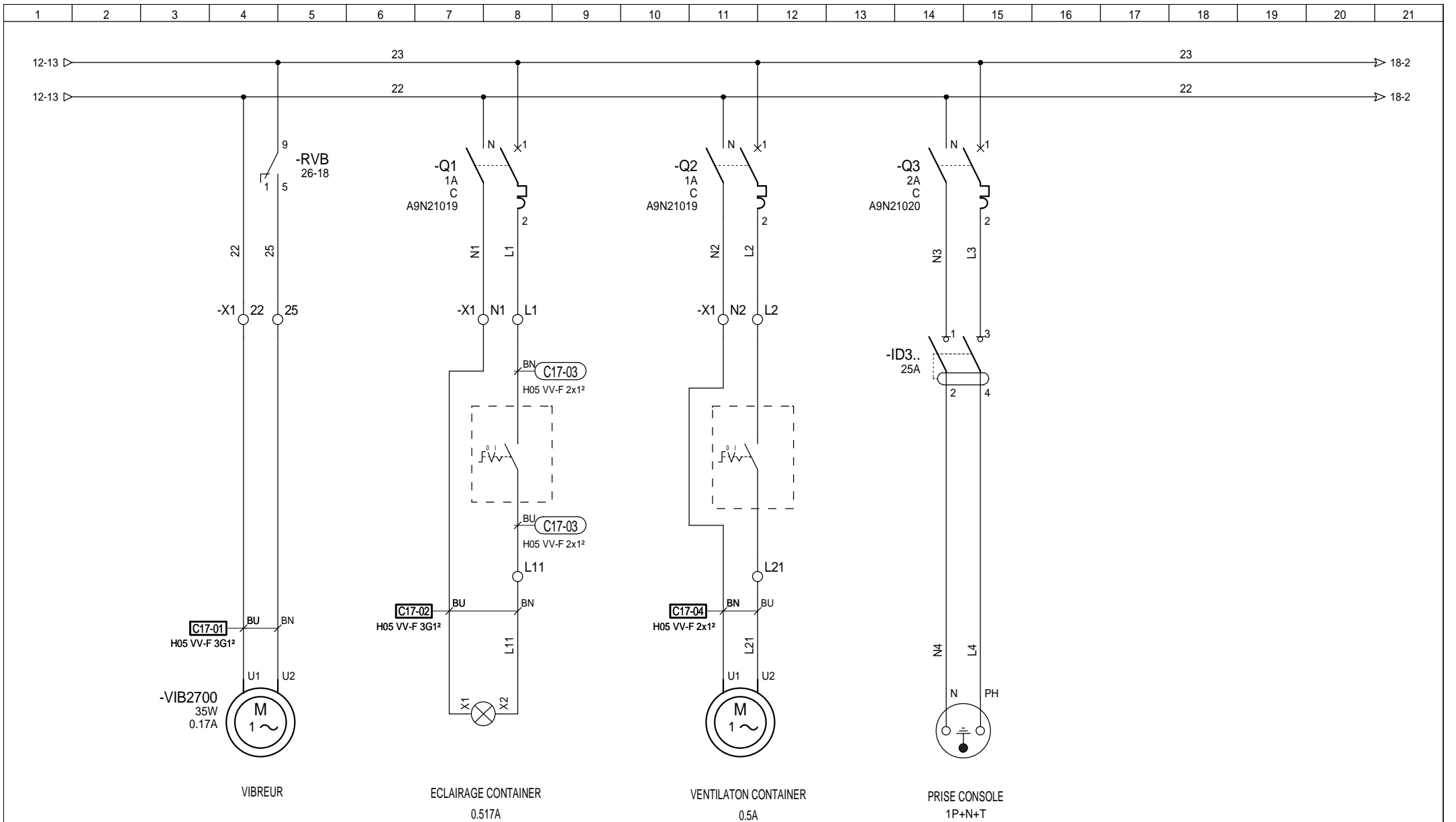

=
+ COFFRET



E.L.S.
ALLEE ANDRE MARIE AMPERE
42500 LE CHAMON FEUGEROLLES

E	21/03/2017	MAJ suite remarques client	ELS
D	20/02/2017	TQC	ELS
C	09/02/2017	MAJ suite remarques client	ELS
A	23/01/2017	Création du dossier	A.F.
INDICE	DATE	MODIFICATION	DES.

CTP ENVIRONNEMENT
Document n° : **ELS1701077**

OPTIFLOW 2
DISTRIBUTION 230V



-Q4
1A
C
OF/25-18

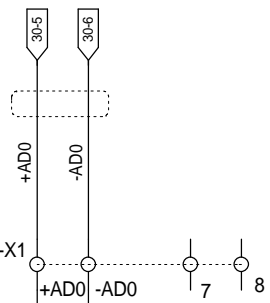
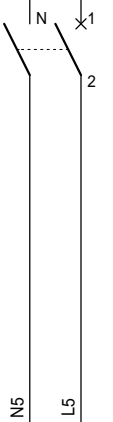

C18-01
H07 RN-F 3G1,5²

C18-02
LiY-CY 4x1²

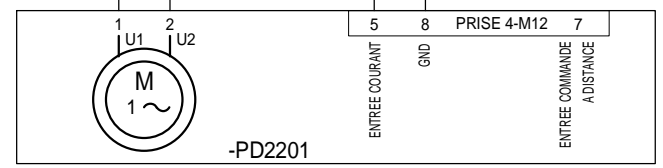

POMPE DOSEUSE

+ COFFRET



E.L.S.
ALLEE ANDRE MARIE AMPERE
42500 LE CHAMON FEUGEROLLES

E	21/03/2017	MAJ suite remarques client	ELS
D	20/02/2017	TQC	ELS
C	09/02/2017	MAJ suite remarques client	ELS
A	23/01/2017	Création du dossier	A.F.
INDICE	DATE	MODIFICATION	DES.

CTP ENVIRONNEMENT

Document n° : **ELS1701077**

OPTIFLOW 2
POMPE DOSEUSE INHIBITEUR DE CORROSION

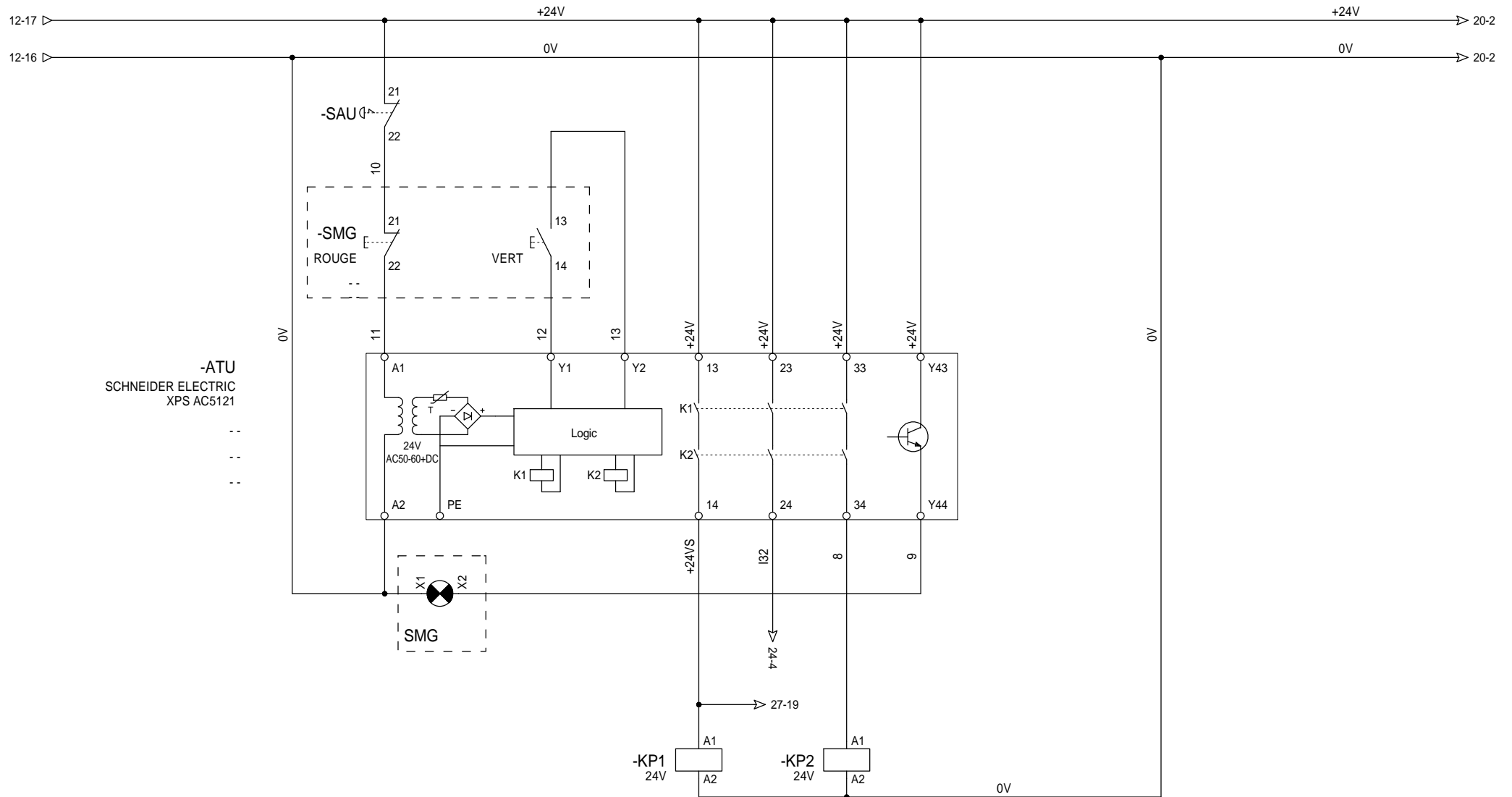

NO	NF	NO	NF
1-2	15-4	1-2	16-4
3-4	15-4	3-4	16-4
5-6	15-4	5-6	16-4
13-14	- -	13-14	- -

+ COFFRET



E.L.S.
 ALLEE ANDRE MARIE AMPERE
 42500 LE CHAMBON FEUGEROLLES

INDICE	DATE	MODIFICATION	DES.
E	21/03/2017	MAJ suite remarques client	ELS
D	20/02/2017	TQC	ELS
C	09/02/2017	MAJ suite remarques client	ELS
A	23/01/2017	Création du dossier	A.F.

CTP ENVIRONNEMENT
 Document n° : **ELS1701077**

OPTIFLOW 2
ARRET D'URGENCE

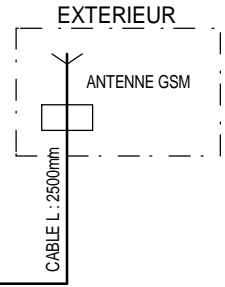
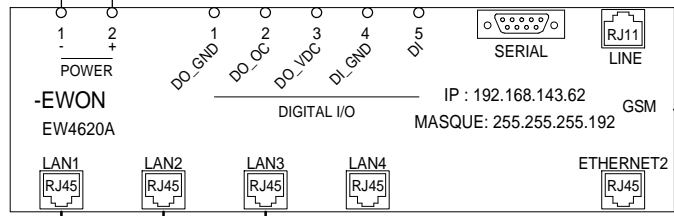
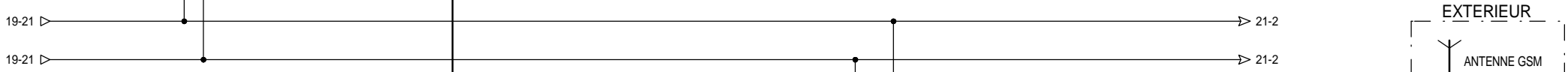
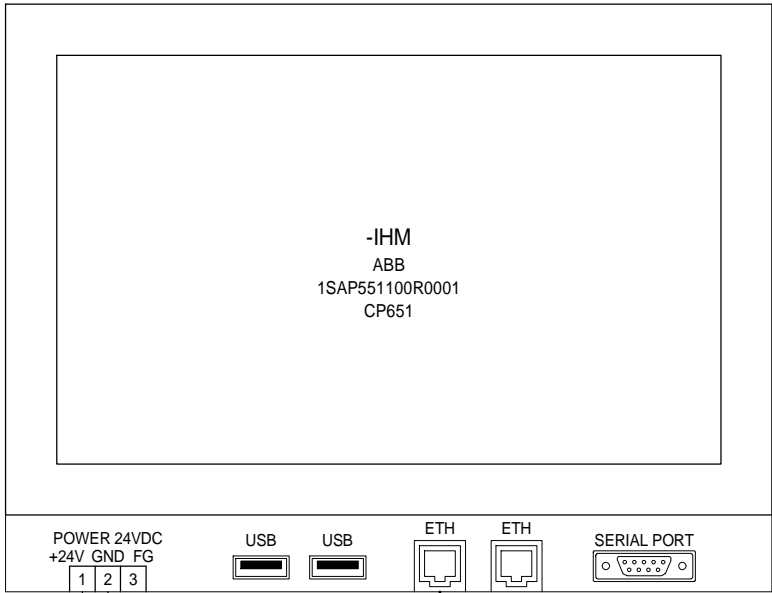

21-12
23-18
BASE CPU/ETHERNET

+ COFFRET



E.L.S.
ALLEE ANDRE MARIE AMPERE
42500 LE CHAMBON FEUGEROLLES

E	21/03/2017	MAJ suite remarques client	ELS
D	20/02/2017	TQC	ELS
C	09/02/2017	MAJ suite remarques client	ELS
A	23/01/2017	Création du dossier	A.F.
INDICE	DATE	MODIFICATION	DES.

CTP ENVIRONNEMENT
Document n° : **ELS1701077**

OPTIFLOW 2
IHM + MODEM

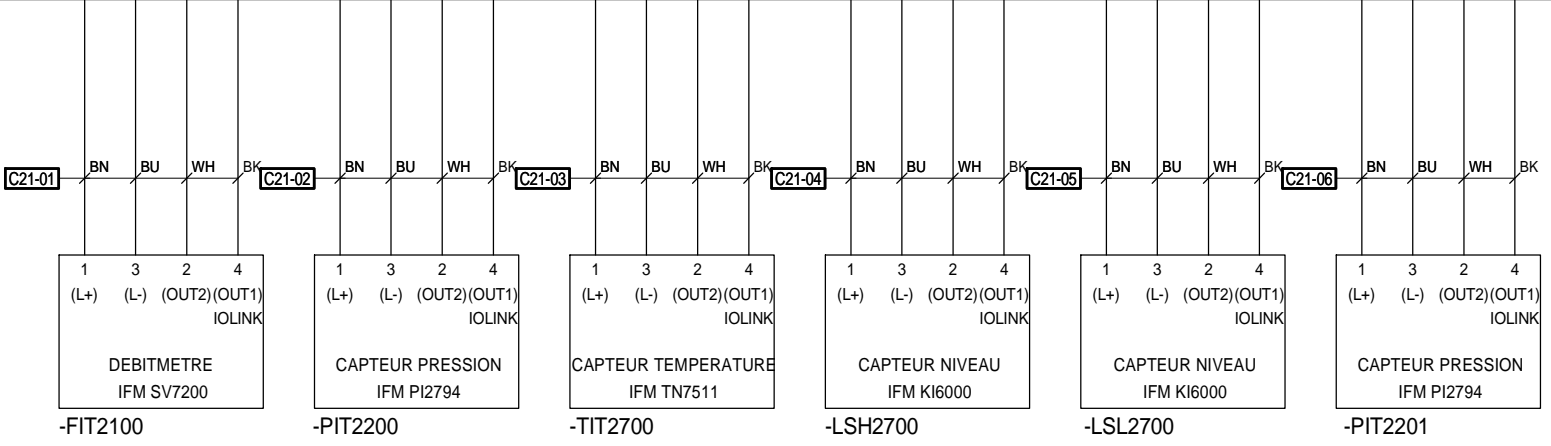
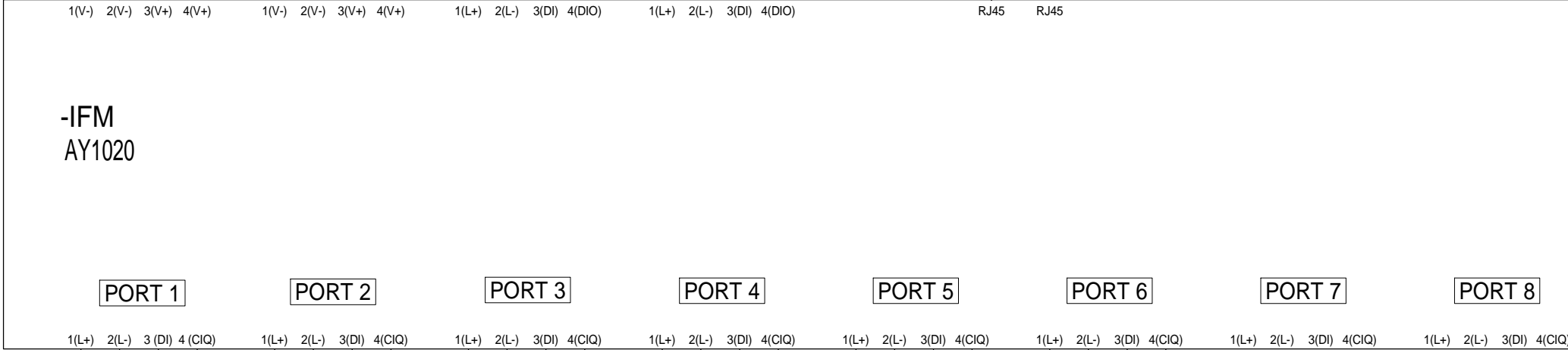
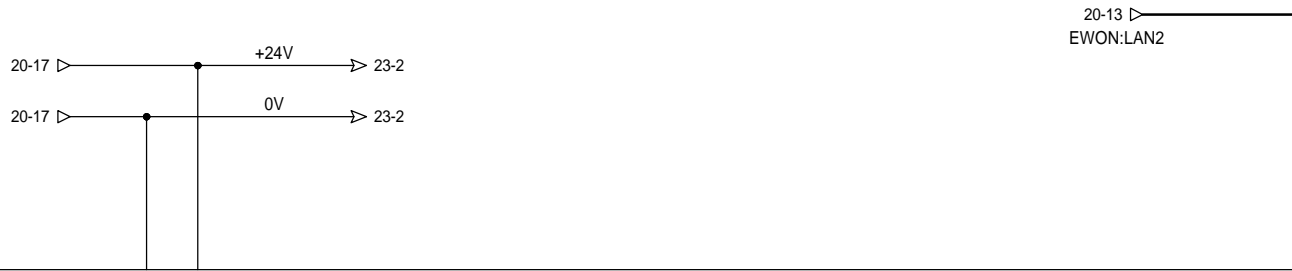

=
+ COFFRET



E.L.S.
ALLEE ANDRE MARIE AMPERE
42500 LE CHAMBON FEUGEROLLES

E	21/03/2017	MAJ suite remarques client	ELS
D	20/02/2017	TQC	ELS
C	09/02/2017	MAJ suite remarques client	ELS
A	23/01/2017	Création du dossier	A.F.
INDICE	DATE	MODIFICATION	DES.

CTP ENVIRONNEMENT
Document n° : **ELS1701077**

OPTIFLOW 2
IFM AY1020

API1 -BASE CPU

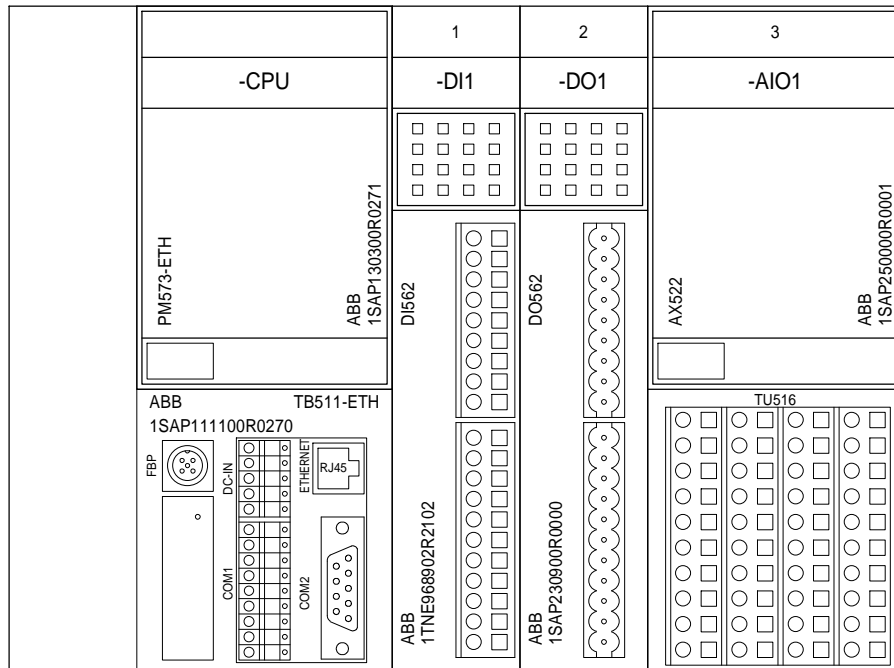

+ COFFRET



E.L.S.
 ALLEE ANDRE MARIE AMPERE
 42500 LE CHAMBON FEUGEROLLES

E	21/03/2017	MAJ suite remarques client	ELS
D	20/02/2017	TQC	ELS
C	09/02/2017	MAJ suite remarques client	ELS
A	23/01/2017	Création du dossier	A.F.
INDICE	DATE	MODIFICATION	DES.

CTP ENVIRONNEMENT
 Document n° : **ELS1701077**

OPTIFLOW 2
 API1 - Configuration Automate

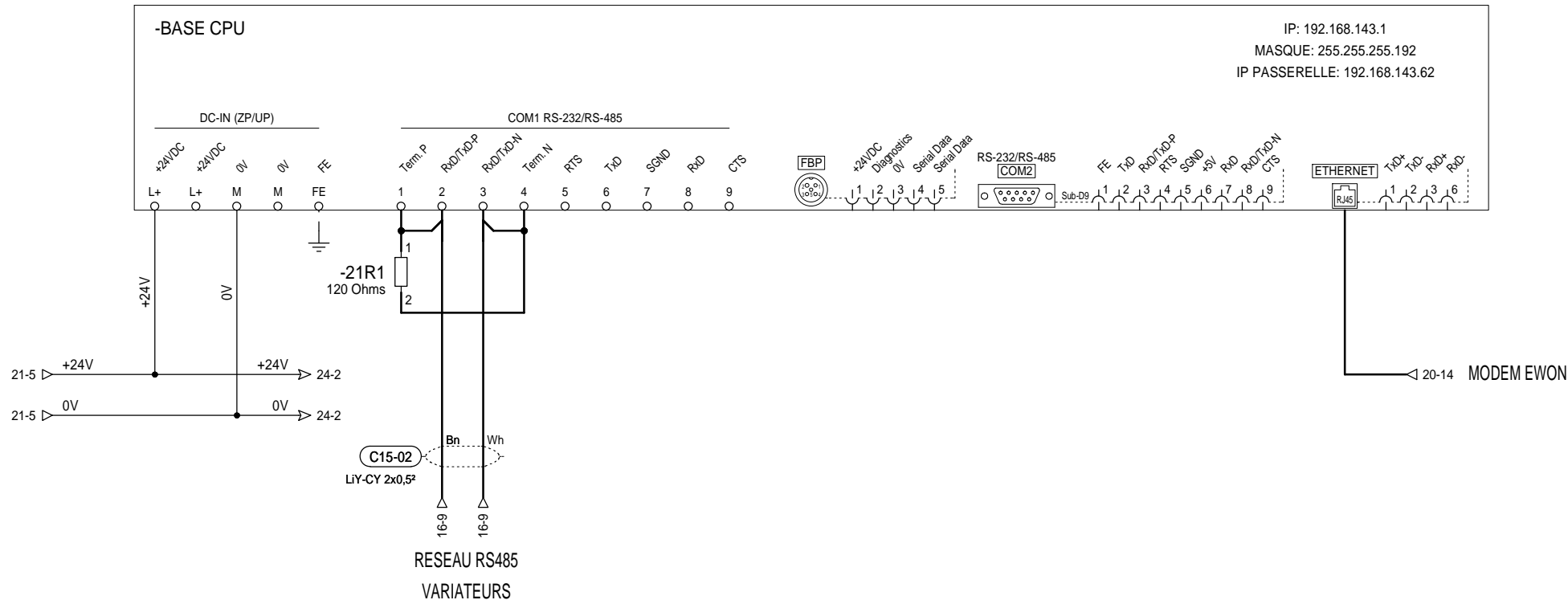

+ COFFRET



E.L.S.
 ALLEE ANDRE MARIE AMPERE
 42500 LE CHAMBON FEUGEROLLES

E	21/03/2017	MAJ suite remarques client	ELS
D	20/02/2017	TQC	ELS
C	09/02/2017	MAJ suite remarques client	ELS
A	23/01/2017	Création du dossier	A.F.
INDICE	DATE	MODIFICATION	DES.

CTP ENVIRONNEMENT
 Document n° : **ELS1701077**

OPTIFLOW 2
 Base CPU - Raccordement

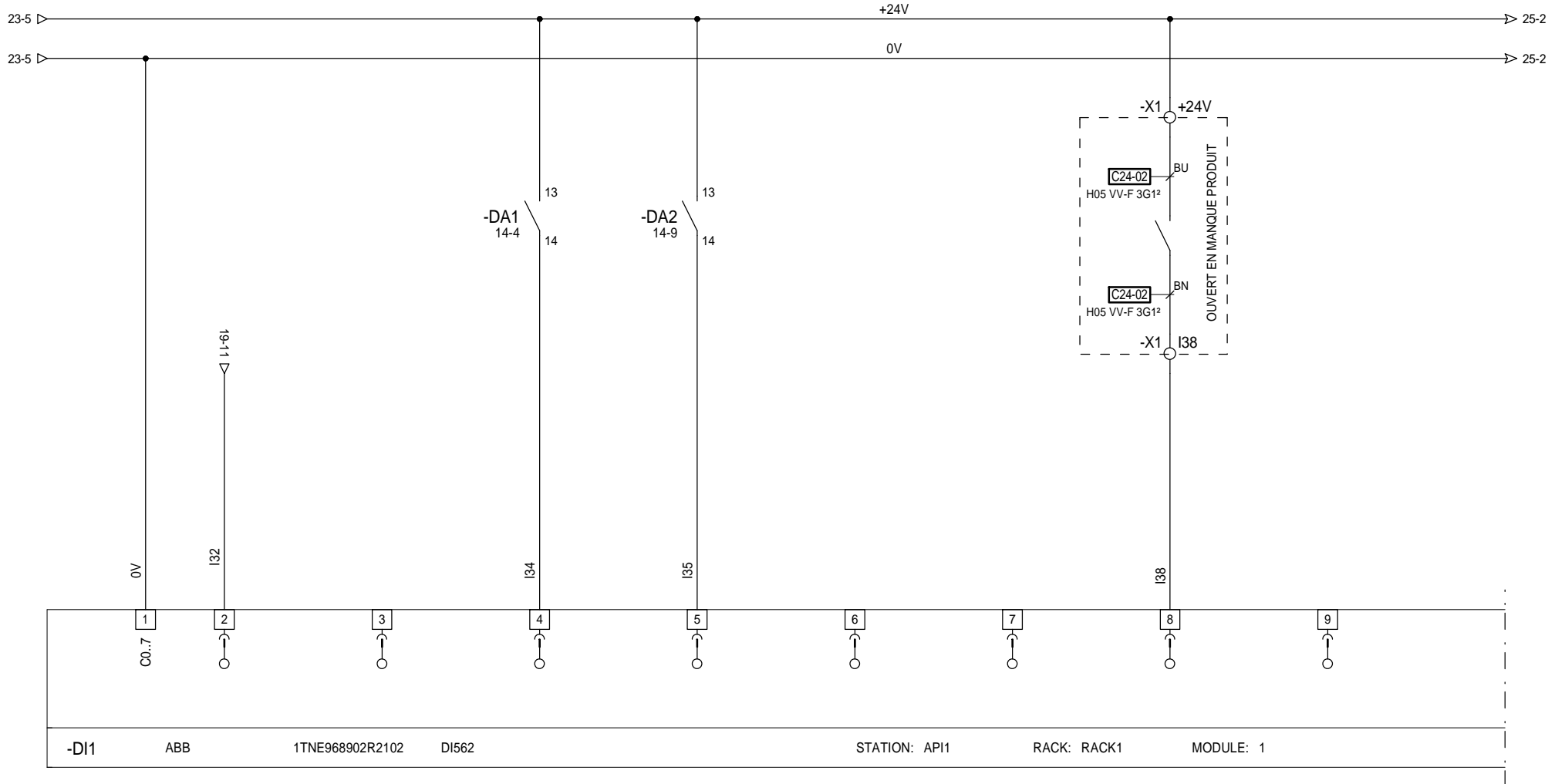
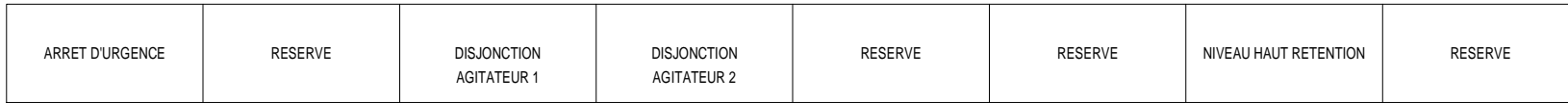

+ COFFRET



E.L.S.
 ALLEE ANDRE MARIE AMPERE
 42500 LE CHAMBON FEUGEROLLES

E	21/03/2017	MAJ suite remarques client	ELS
D	20/02/2017	TQC	ELS
C	09/02/2017	MAJ suite remarques client	ELS
A	23/01/2017	Création du dossier	A.F.
INDICE	DATE	MODIFICATION	DES.

CTP ENVIRONNEMENT

Document n° : **ELS1701077**

OPTIFLOW 2
 DI1 - Module d'entrées

NIVEAU TRES BAS CUVE	NIVEAU BAS CUVE	NIVEAU HAUT CUVE	NIVEAU TRES HAUT CUVE	LIBRE	LIBRE	LIBRE	DEFAULT POMPE DOSEUSE
----------------------	-----------------	------------------	-----------------------	-------	-------	-------	-----------------------

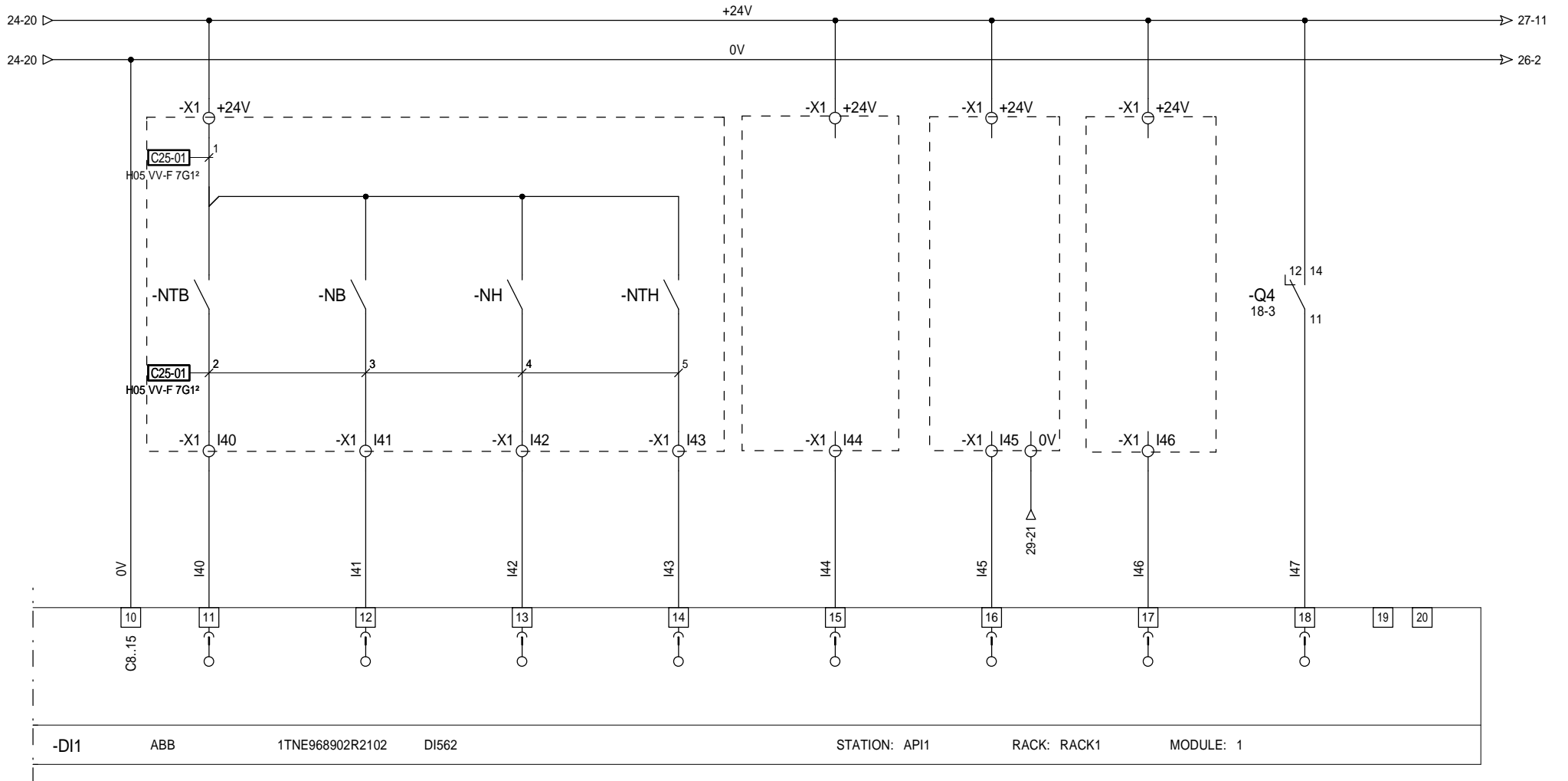

-DI1 ABB 1TNE968902R2102 DI562 STATION: API1 RACK: RACK1 MODULE: 1

+ COFFRET



E.L.S.
 ALLEE ANDRE MARIE AMPERE
 42500 LE CHAMBON FEUGEROLLES

E	21/03/2017	MAJ suite remarques client	ELS
D	20/02/2017	TQC	ELS
C	09/02/2017	MAJ suite remarques client	ELS
A	23/01/2017	Création du dossier	A.F.
INDICE	DATE	MODIFICATION	DES.

CTP ENVIRONNEMENT
 Document n° : **ELS1701077**

OPTIFLOW 2
 DI1 - Module d'entrées

RESERVE	RESERVE	RESERVE	AGITATEUR 1	AGITATEUR 2	EV2101 E.V. EAU BAC 2	EV2100 E.V. EAU BAC 1	VIBREUR AUTOLIFT
---------	---------	---------	-------------	-------------	--------------------------	--------------------------	------------------

-DO1 ABB 1SAP230900R0000 DO562 STATION: API1 RACK: RACK1 MODULE: 4

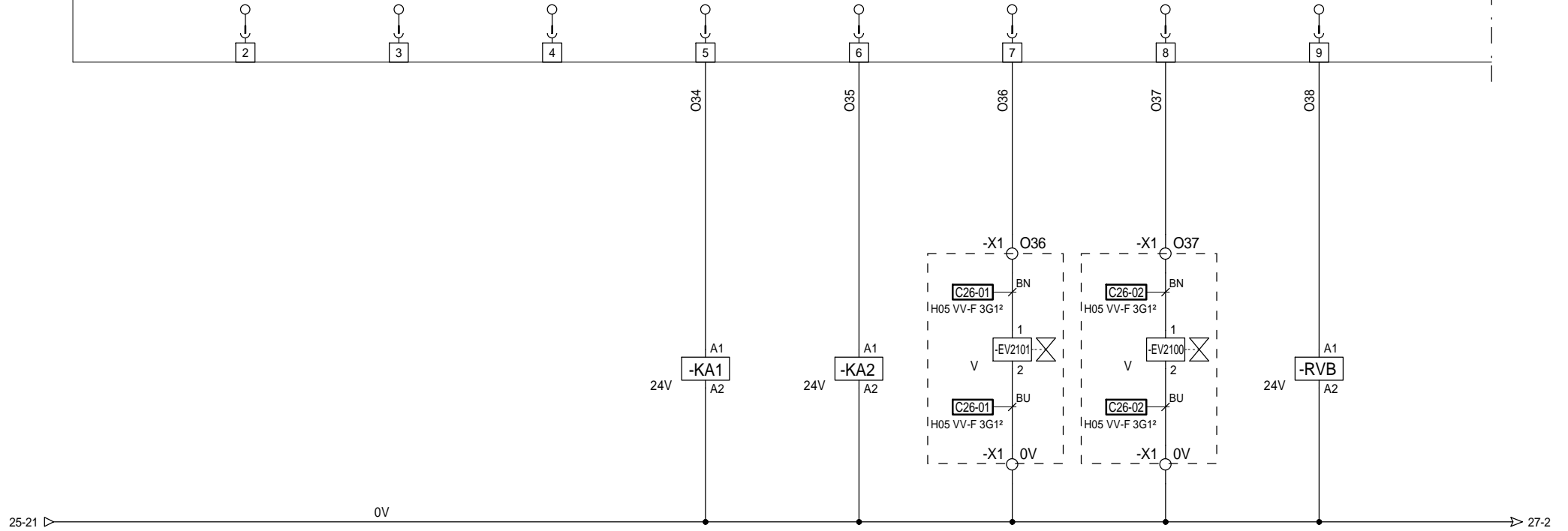

NO	NF
1-2	14-4
3-4	14-4
5-6	14-4
13-14	- -

NO	NF
1-2	14-9
3-4	14-9
5-6	14-9
13-14	- -

NO	NF
9-1-5	17-5
10-2-6	- -
11-3-7	- -
12-4-8	- -

+ COFFRET



E.L.S.
ALLEE ANDRE MARIE AMPERE
42500 LE CHAMBON FEUGEROLLES

E	21/03/2017	MAJ suite remarques client	ELS
D	20/02/2017	TQC	ELS
C	09/02/2017	MAJ suite remarques client	ELS
A	23/01/2017	Création du dossier	A.F.
INDICE	DATE	MODIFICATION	DES.

CTP ENVIRONNEMENT
Document n° : **ELS1701077**

OPTIFLOW 2
DO1 - Module de sorties

EV2800 EV VAPEUR	RESERVE	RESERVE	EV2200 E.V. DECHARGE ACIDE	RESERVE	RESERVE	RESERVE	RESERVE
---------------------	---------	---------	-------------------------------	---------	---------	---------	---------

-DO1 ABB 1SAP230900R0000 DO562 STATION: API1 RACK: RACK1 MODULE: 4

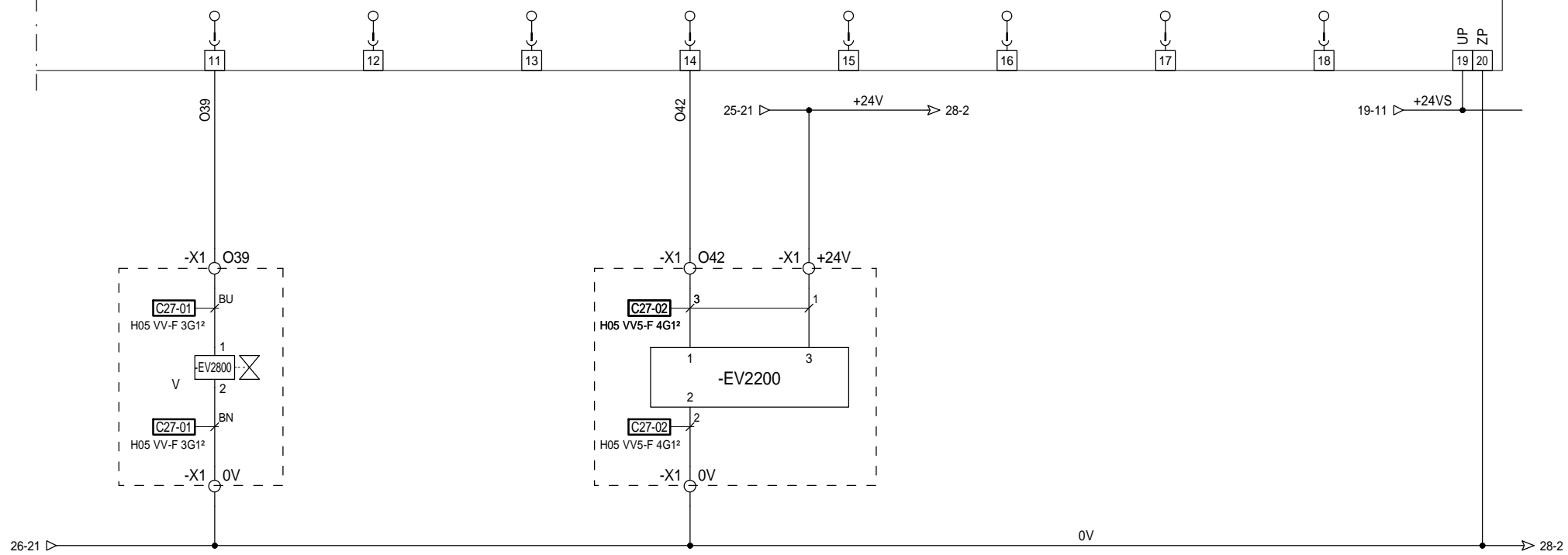

+ COFFRET



E.L.S.
ALLEE ANDRE MARIE AMPERE
42500 LE CHAMBON FEUGEROLLES

E	21/03/2017	MAJ suite remarques client	ELS
D	20/02/2017	TQC	ELS
C	09/02/2017	MAJ suite remarques client	ELS
A	23/01/2017	Création du dossier	A.F.
INDICE	DATE	MODIFICATION	DES.

CTP ENVIRONNEMENT
Document n° : **ELS1701077**

OPTIFLOW 2
DO1 - Module de sorties

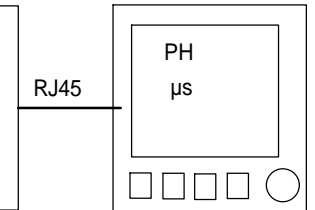
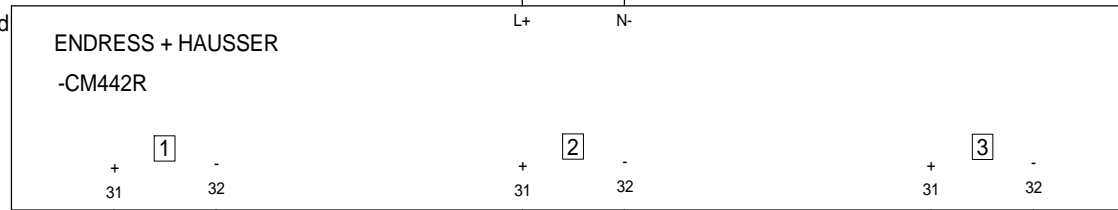
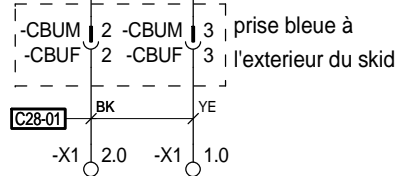
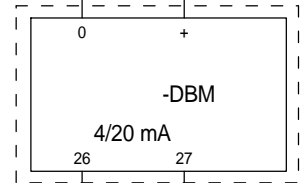
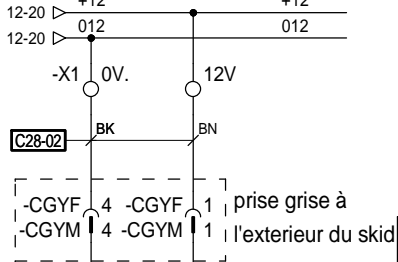
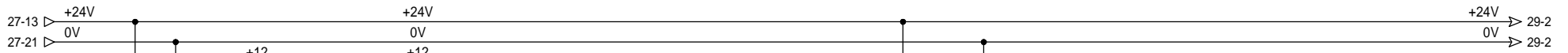
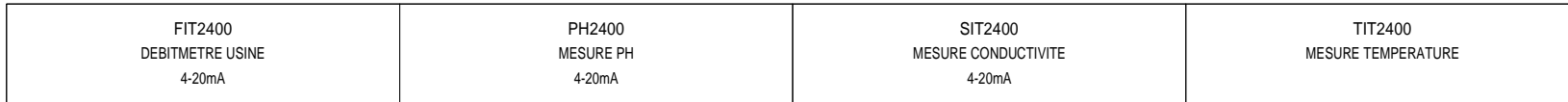

-AIO1 ABB 1SAP250000R0001 AX522+TU516 STATION: APIx RACK: RACKx MODULE: 1

+ COFFRET



E.L.S.
 ALLEE ANDRE MARIE AMPERE
 42500 LE CHAMBON FEUGEROLLES

E	21/03/2017	MAJ suite remarques client	ELS
D	20/02/2017	TQC	ELS
C	09/02/2017	MAJ suite remarques client	ELS
A	23/01/2017	Création du dossier	A.F.
INDICE	DATE	MODIFICATION	DES.

CTP ENVIRONNEMENT

Document n° : **ELS1701077**

OPTIFLOW 2
 AIO1 - Module d'entrées/sorties

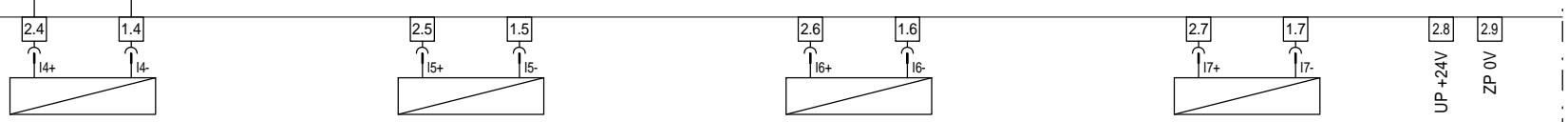
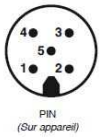
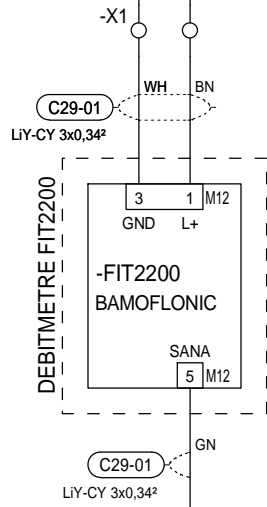
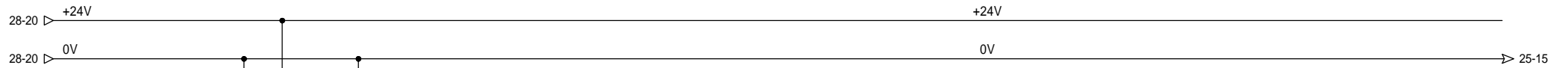

-AIO1 ABB 1SAP250000R0001 AX522+TU516 STATION: APIx RACK: RACKx MODULE: 1

+ COFFRET



E.L.S.
ALLEE ANDRE MARIE AMPERE
42500 LE CHAMBON FEUGEROLLES

E	21/03/2017	MAJ suite remarques client	ELS
D	20/02/2017	TQC	ELS
C	09/02/2017	MAJ suite remarques client	ELS
INDICE	DATE	MODIFICATION	DES.

CTP ENVIRONNEMENT
Document n° : **ELS1701077**

OPTIFLOW 2
AIO1 - Module d'entrées/sorties



-AIO1 ABB 1SAP250000R0001 AX522+TU516 STATION: APIx RACK: RACKx MODULE: 1

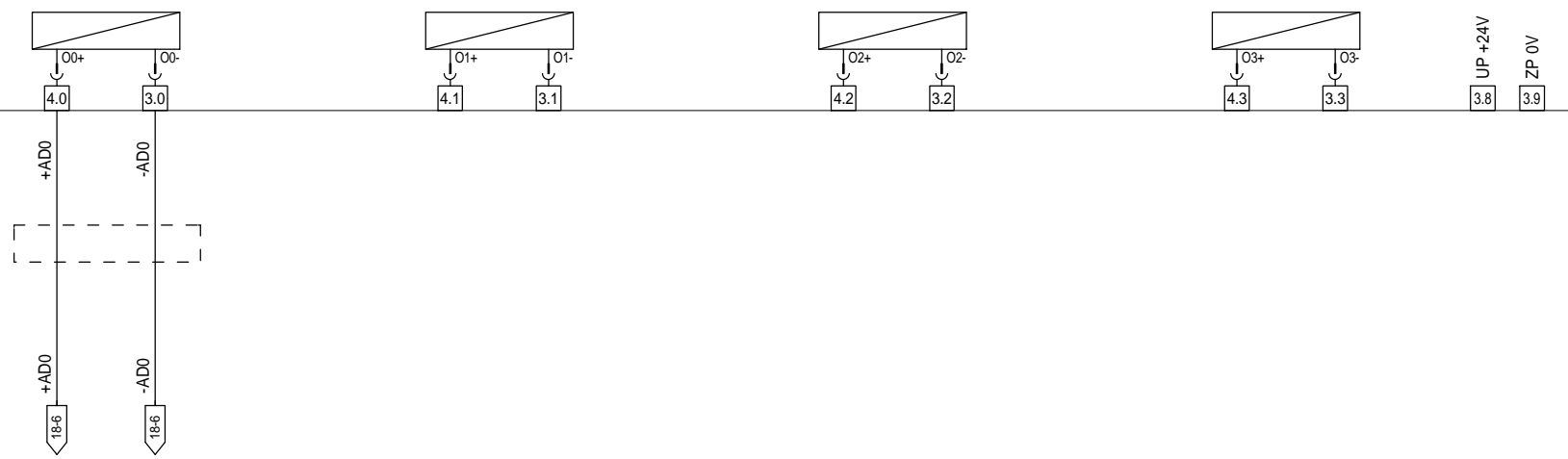

+ COFFRET



E.L.S.
ALLEE ANDRE MARIE AMPERE
42500 LE CHAMBON FEUGEROLLES

E	21/03/2017	MAJ suite remarques client	ELS
D	20/02/2017	TQC	ELS
C	09/02/2017	MAJ suite remarques client	ELS
A	23/01/2017	Création du dossier	A.F.
INDICE	DATE	MODIFICATION	DES.

CTP ENVIRONNEMENT

Document n° : **ELS1701077**

OPTIFLOW 2
AIO1 - Module d'entrées/sorties

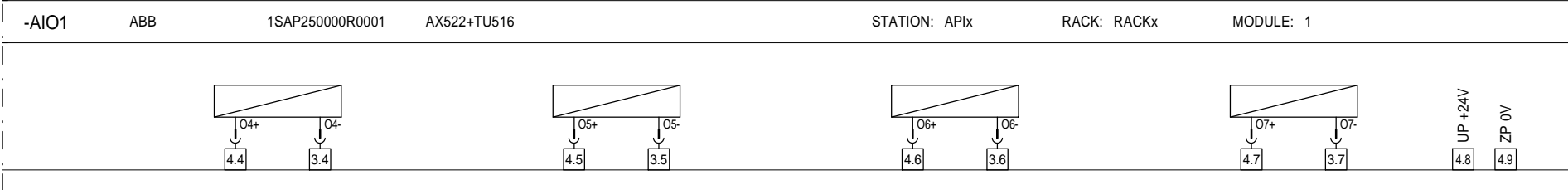

+ COFFRET



E.L.S.
 ALLEE ANDRE MARIE AMPERE
 42500 LE CHAMBON FEUGEROLLES

E	21/03/2017	MAJ suite remarques client	ELS
D	20/02/2017	TQC	ELS
C	09/02/2017	MAJ suite remarques client	ELS
INDICE	DATE	MODIFICATION	DES.

CTP ENVIRONNEMENT

Document n° : **ELS1701077**

OPTIFLOW 2
 AIO1 - Module d'entrées/sorties

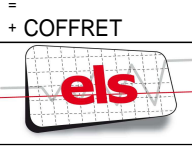
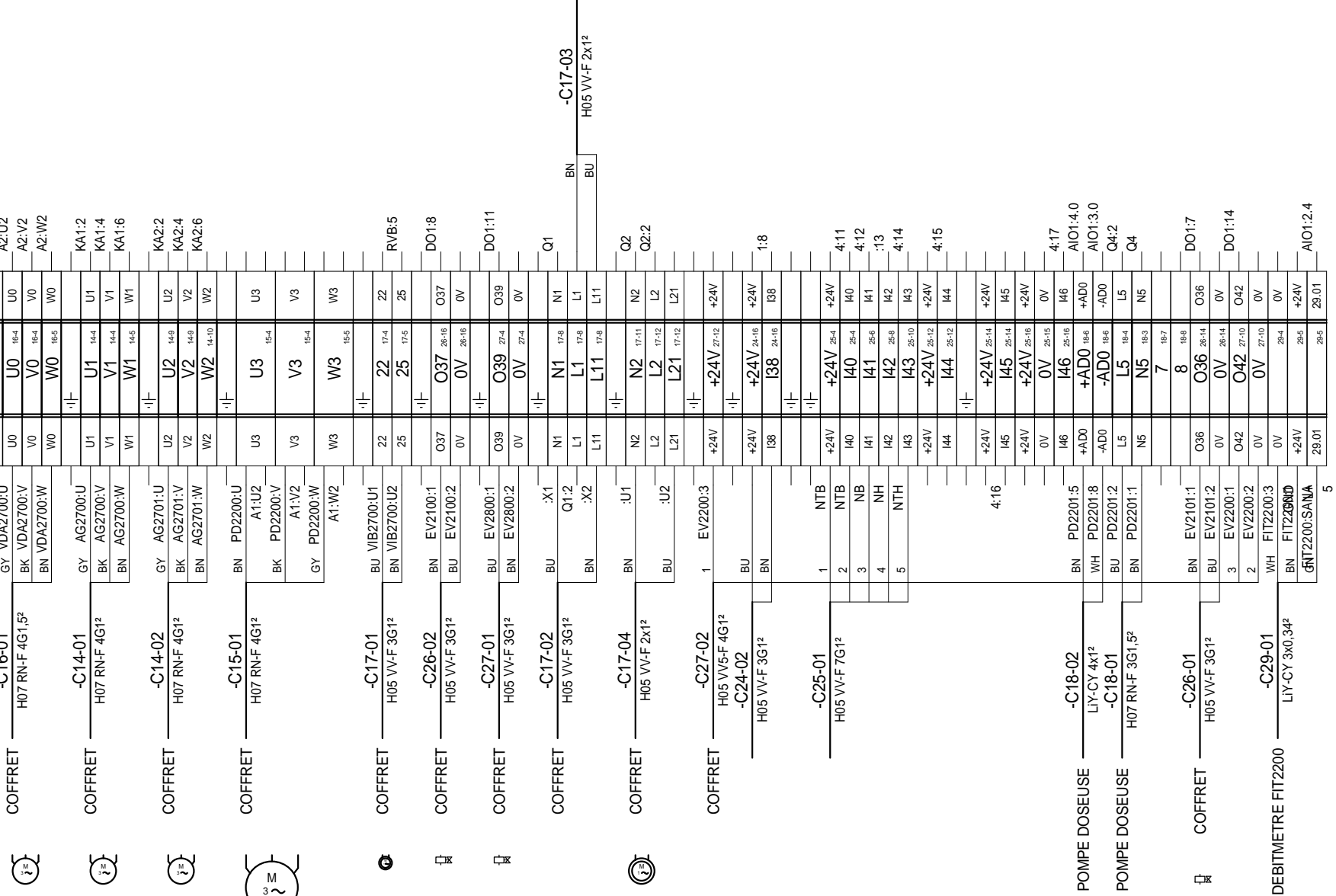
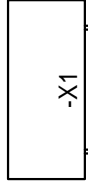

E.L.S.
 ALLEE ANDRE MARIE AMPERE
 42500 LE CHAMBON FEUGEROLLES

E	21/03/2017	MAJ suite remarques client	ELS
D	20/02/2017	TQC	ELS
C	09/02/2017	MAJ suite remarques client	ELS
B	09/02/2017	Deplacement de AU	AF
INDICE	DATE	MODIFICATION	DES.

CTP ENVIRONNEMENT
 Document n° : **ELS1701077**

OPTIFLOW 2
 Bornier : +COFFRET-X1
 1/2

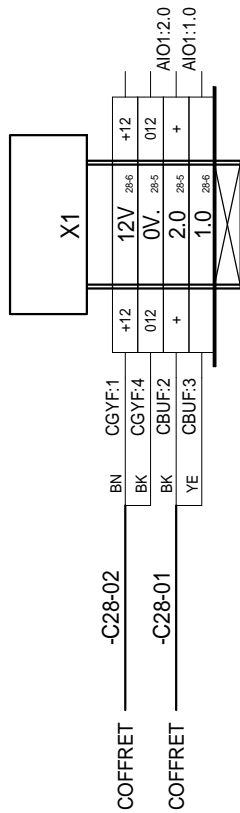

=
+ COFFRET



E.L.S.
ALLEE ANDRE MARIE AMPERE
42500 LE CHAMBON FEUGEROLLES

E	21/03/2017	MAJ suite remarques client	ELS
D	20/02/2017	TQC	ELS
C	09/02/2017	MAJ suite remarques client	ELS
B	09/02/2017	Deplacement de AU	AF
INDICE	DATE	MODIFICATION	DES.

CTP ENVIRONNEMENT
Document n° : **ELS1701077**

OPTIFLOW 2
Bornier : +COFFRET-X1
2/2

REPERE	FOLIO	DESIGNATION	REFERENCE	FABRICANT	QTE
1	24	MODULE D'ENTREES TOR 16E, 24VDC	1TNE968902R2102	ABB	1
4	25	MODULE D'ENTREES TOR 16E, 24VDC	1TNE968902R2102	ABB	1
21R1	23	RESISTANCE 120Ω 0.25W	RESISTANCE 120Ω 0.25W		1
A1	15	VARIATEUR ACS310 EN MONTAGE MURAL, 4kW, 9.7A, 380-480VAC TRI + MICRO-CONSOLE	ACS310-03E-09A7-4+J404	ABB	1
A2	16	VARIATEUR ACS310 EN MONTAGE MURAL, 1.1kW, 3.6A, 380-480VAC TRI + MICRO-CONS	ACS310-03E-03A6-4+J404	ABB	1
AIO1	22	EMBASE TU516 POUR MODULE E/S, 24VDC, 40 BORNES A RESSORT	1SAP212000R0001	ABB	1
AIO1	22	MODULE D'ENTREES/SORTIES 8E/8S ANA U/I/Pt100, -10/0...10V, 0/4...20mA	1SAP250000R0001	ABB	1
AL1	12	ALIMENTATION A DECOUPAGE PRIMAIRE 400-500VAC TRI, SORTIE 24VDC 5A	2866462	PHOENIX CONTACT	1
ATU	19	MODULE DE SECURITE PREVENTA POUR SURVEILLANCE AU - XPS AC, 24V AC/DC	XPS AC5121	SCHNEIDER ELECTRIC	1
BASE CPU	22	EMBASE TB511-ETH POUR CPU AC500, 1xCPU, 1xCOUPLEUR, ETHERNET RJ45	1SAP111100R0270	ABB	1
COFFRET	12	SPACIAL S3D - CHÂSSIS TELEQUICK 1000X600	NSYMR106	SCHNEIDER ELECTRIC	1
COFFRET	12	COFFRET UNIVERSEL AVEC PORTE PLEINE SANS CHASSIS 1000x600x300, IP66, RAL703	NSYS3D10630	SCHNEIDER ELECTRIC	1
CPU	22	MODULE CENTRALE CPU AC500 512kB, ETHERNET 24VDC 2xRS232/485	1SAP130300R0271	ABB	1
DA1	14	DISJONCTEUR MOTEUR THERMIQUE 1,6-2,5A	GV2ME07	SCHNEIDER ELECTRIC	1
DA1	14	ADDITIF FRONTAL F+O	GVAE11	SCHNEIDER ELECTRIC	1
DA2	14	DISJONCTEUR MOTEUR THERMIQUE 1,6-2,5A	GV2ME07	SCHNEIDER ELECTRIC	1
DA2	14	ADDITIF FRONTAL F+O	GVAE11	SCHNEIDER ELECTRIC	1
DAU	16	DISJONCTEUR MOTEUR MAGNETIQUE 6,3A	GV2L10	SCHNEIDER ELECTRIC	1
DI1	22	MODULE D'ENTREES TOR 16E, 24VDC	1TNE968902R2102	ABB	1
DO1	22	MODULE DE SORTIES TOR, 16S TRANSISTOR 24VDC	1SAP230900R0000	ABB	1
DP1	15	DISJONCTEUR MOTEUR MAGNETIQUE 10A	GV2L14	SCHNEIDER ELECTRIC	1
DP1	15	ADDITIF FRONTAL F+O	GVAE11	SCHNEIDER ELECTRIC	1
EWON	20	MODEM ROUTEUR INDUSTRIELLE VPN LAN eWON4005CD, ALIM. 12-24VDC	EW4620A	EWON	1
ID3..	17	ITG40 CLASSE AC BI 230VAC 25A 30mA	A9N21520	SCHNEIDER ELECTRIC	1
IG	12	INTERRUPTEUR SECTIONNEUR PRINC.AU 63A	VCF3	SCHNEIDER ELECTRIC	1
IHM	20	TERMINAL OPERATEUR CP651, 10.4" ECRAN TACTILE TFT, 64k COULEURS, 800x600 PI	1SAP551100R0001	ABB	1
KA1	26	CONTACTEUR DE PUISSANCE 3P+F VIS 24VDC	LP1K0910BD	SCHNEIDER ELECTRIC	1
KA2	26	CONTACTEUR DE PUISSANCE 3P+F VIS 24VDC	LP1K0910BD	SCHNEIDER ELECTRIC	1
KP1	19	CONTACTEUR DE PUISSANCE 3P+F VIS 24VDC	LP1K0910BD	SCHNEIDER ELECTRIC	1
KP2	19	CONTACTEUR DE PUISSANCE 3P+F VIS 24VDC	LP1K0910BD	SCHNEIDER ELECTRIC	1
PC1	17	PRISE DE COURANT LEXIC 10/16A, 250VAC, 2P+T A ECLIPS	004280	LEGRAND	1
PR	12	DISJONCTEUR 2P MONO 2A 230V	GB2DB07	SCHNEIDER ELECTRIC	1

+ COFFRET

REPERE	FOLIO	DESIGNATION	REFERENCE	FABRICANT	QTE
PR2	12	DISJONCTEUR 2P MONO 2A 230V	GB2DB07	SCHNEIDER ELECTRIC	1
Q1	17	DISJONCTEUR DT40 1P+N 1A 6kA, COURBE C	A9N21019	SCHNEIDER ELECTRIC	1
Q2	17	DISJONCTEUR DT40 1P+N 1A 6kA, COURBE C	A9N21019	SCHNEIDER ELECTRIC	1
Q3	17	DISJONCTEUR DT40 1P+N 2A 6kA, COURBE C	A9N21020	SCHNEIDER ELECTRIC	1
Q4	18	DISJONCTEUR DT40 1P+N 1A 6kA, COURBE C	A9N21019	SCHNEIDER ELECTRIC	1
Q4	18	CONTACT AUXILIAIRE OF	A9N26924	SCHNEIDER ELECTRIC	1
REP	12	REPARTITEUR MODULAIRE MONOBLOC TETRAPOLAIRE, 100A, 5+2 CONNEXIONS	004884	LEGRAND	1
RVB	26	RELAIS 24V DC 4INV AgNi 5A var.0040 MONT. SUR SUPPORT	553490240040	FINDER	1
RVB	26	SUPPORT AVEC BORNES A CAGES POUR RELAIS SERIE 55, ETRIER METALLIQUE	94842SMA	FINDER	1
SAU	19	ARRET D'URGENCE	XB5AS8445	SCHNEIDER ELECTRIC	1
SE	12	DISJONCTEUR DT40 1P+N 2A 6kA, COURBE C	A9N21020	SCHNEIDER ELECTRIC	1
SE	12	BLOC VIGI DT40 1P+N CLASSE AC 25A 30mA 230VAC	A9N21450	SCHNEIDER ELECTRIC	1
SE2	12	DISJONCTEUR C60H-DC 250VDC 5A 1P C	A9N61505	SCHNEIDER ELECTRIC	1
SMG	19	BOUTON POUSSOIR LUMINEUX F+O +VOYANT 24V	XB5AW73731B5	SCHNEIDER ELECTRIC	1
TR	12	TRANSFORMATEUR DE COMMANDE ET DE SIGNALISATION MONOPHASEE 230-400V/115-230V	044266	LEGRAND	1
X1	40	BLOC DE LIAISON, 4mm2, 35A, GRIS, RACCORDEMENT VISEE	1SNA115116R0700	ENTRELEC	66

+ COFFRET



E.L.S.
 ALLEE ANDRE MARIE AMPERE
 42500 LE CHAMBON FEUGEROLLES

E	21/03/2017	MAJ suite remarques client	ELS
D	20/02/2017	TQC	ELS
C	09/02/2017	MAJ suite remarques client	ELS
B	09/02/2017	Deplacement de AU	AF
INDICE	DATE	MODIFICATION	DES.

CTP ENVIRONNEMENT

Document n° : **ELS1701077**

OPTIFLOW 2
 Nomenclature matériel