

INDICE	PREMIERE EDITION	MODIFICATION	DATE	DESINE	VERIFIE	APPROUVE
A			10/06/2021	CTP	CTP	CTP



CTP ENVIRONNEMENT

ZAC des Gaulhes, 2076 avenue Henri Schneider
 69330 JONAGE
 TEL : 04 72 47 72 14 FAX : 04 72 47 01 13

CTP-EC-001

POMPE PC006 & PC007

SCHEMAS ELECTRIQUES

PAGE DE GARDE

DOCUMENT N° : CTP-SCE-21001

01/14

CE DOCUMENT EST NOTRE PROPRIETE. IL EST REMIS A TITRE CONFIDENTIEL.
 IL NE DOIT PAS ETRE REPRODUIT OU COMMUNIQUE A DES TIERS SANS NOTRE AUTORISATION ECRITE

CIRCUIT	TYPE	COULEUR	REPERAGE
---------	------	---------	----------

CIRCUIT PUISSANCE : NON COUPE PAR SECTIONNEUR GENERAL

400VAC	Phase 1	FI ORANGE	Manchon Noir
400VAC	Phase 2	FI ORANGE	Manchon Noir
400VAC	Phase 3	FI ORANGE	Manchon Noir
230VAC	Neutre	FI ORANGE	Manchon Bleu Clair
		Terre	FI V/U

CIRCUIT PUISSANCE : COUPE PAR SECTIONNEUR GENERAL

400VAC	Phase 1	Noir	REPERE n°FI *
400VAC	Phase 2	Noir	REPERE n°FI *
400VAC	Phase 3	Noir	REPERE n°FI *
230VAC	Neutre	Bleu Clair	REPERE n°FI *

CIRCUIT COMMANDE :

24VAC	Commun (+)	Rouge	REPERE n°FI *
0VAC	Commun (-)	Blanc	REPERE n°FI *
24VDC	Commun (+)	Violet	REPERE n°FI *
0 VAC	Commun (-)	Bleu Foncé RAL	REPERE n°FI *
		Terre	REPERE n°FI *
		FI V/U	REPERE n°FI *

PRINCIPE DE REPERAGE

CIRCUIT PUISSANCE & COMMANDE

Alimentation 400V : "L" et "Num Ordre" Exemple: L1,L2
 Alimentation 230V phase : "L" et "Num Ordre" et Exemple: L1,L2
 Alimentation 230V neutre : "N" et "Num Ordre" et Exemple: L1,L2
 Alimentation 24V : "Transition" et "Num Ordre" et Exemple: 24V1,0V1
 Autres : "Num Fais" et "Num Ordre" et Exemple: 10,01,10,02

SECTION FILIERIE	AMPERAGE
------------------	----------

1,5 mm2	10 A
2,5 mm2	20 A
4 mm2	25 A
6 mm2	32 A
10 mm2	50 A
16 mm2	63 A

+ COFFRET

CTP Environnement
 ZAC des gaulines
 2076 Avenue Henri Schneider
 69330 JONAGE

CTP ENVIRONNEMENT
 Document n° : **CTP-SCE-21001**

INDICE A 1000/2021
 DATE 10/09/2021
 PREMIERE EDITION
 MODIFICATION

CTP-EC-001
 REPERAGE ET SECTION FILIERIE

FOLIO **03**
 ◀ 01 05 ▶



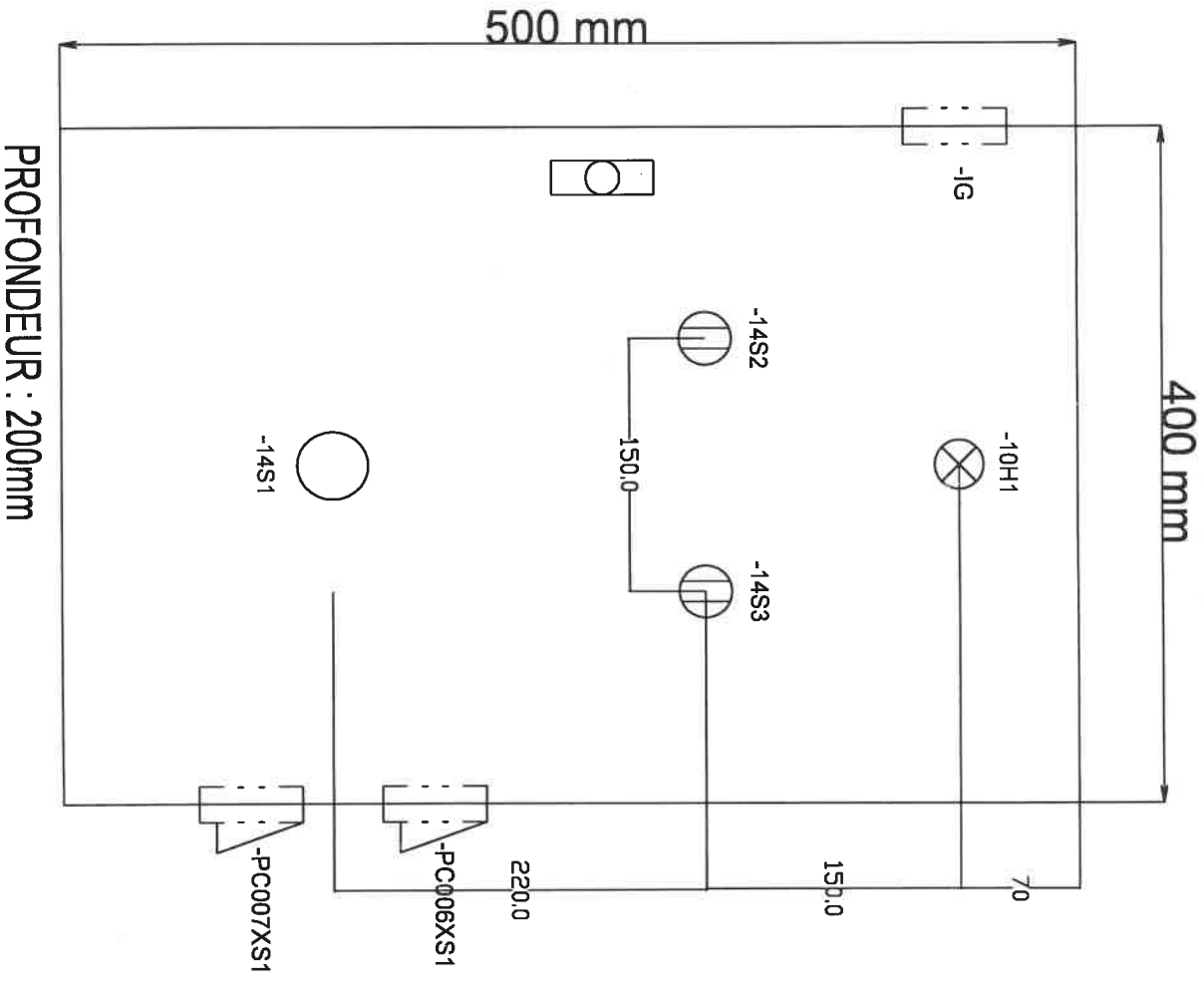

+ COFFRET



CTP Environnement
 ZAC des gaulhes
 2076 Avenue Henri Schneider
 69330 JONAGE

INDICE	DATE	PREMIERE EDITION	MODIFICATION
A	10/06/2021		

CTP ENVIRONNEMENT
 Document n° : **CTP-SCE-21001**

CTP-EC-001
 IMPLANTATION

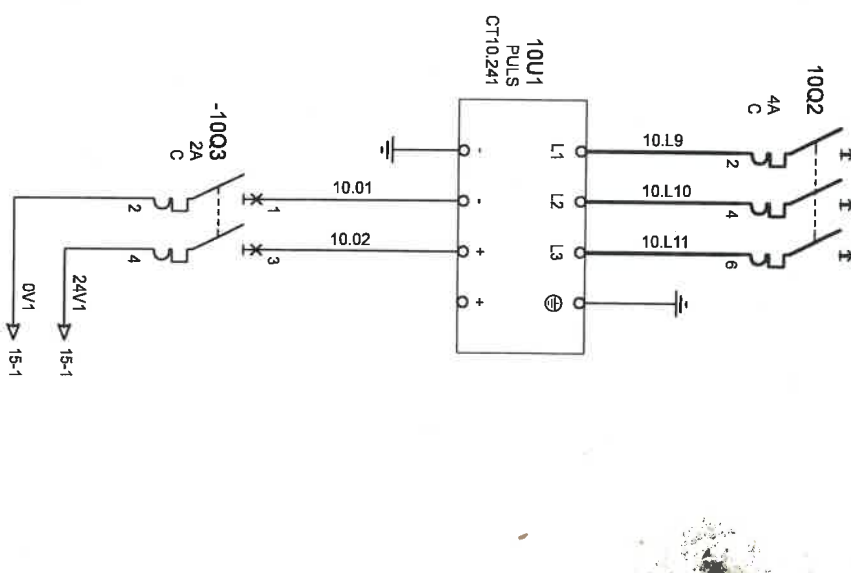
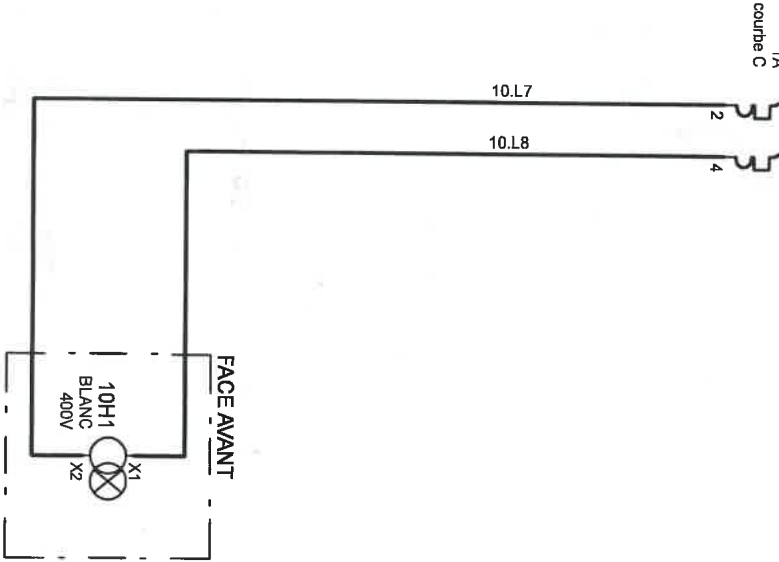
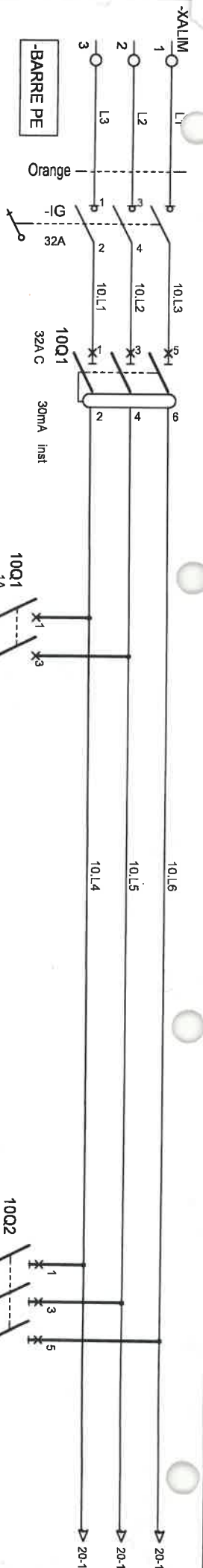

COFFRET



CTP Environnement
ZAC des gaulhès
2076 Avenue Henri Schneider
69330 JONAGE

INDICE	A	1008/2021	PREMIERE EDITION	CTP
DATE			MODIFICATION	DES.

CTP ENVIRONNEMENT
Document n° : **CTP-SCE-21001**

CTP-EC-001
ALIMENTATION

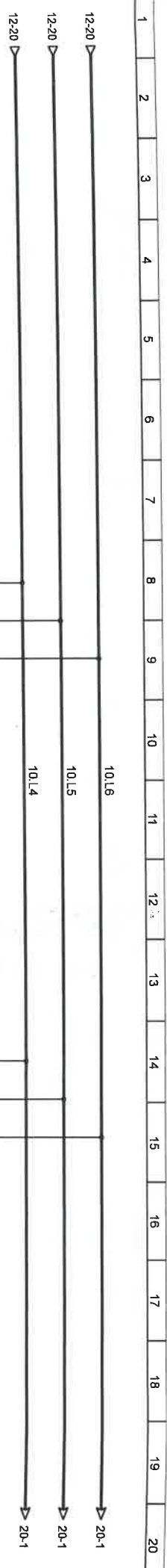

-11QM1
16-20A
18A
13-14 NO/10-12
21-22 NF/10-20

-11KM1
10-12

-11QM2
16-20A
18A
13-14 NO/10-12
21-22 NF/10-20

-11KM2
10-12

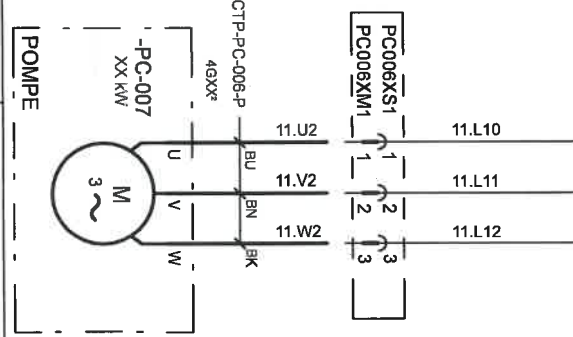
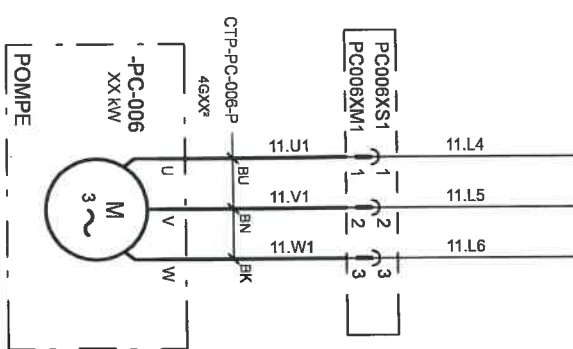

+ COFFRET		CTP Environnement		Document n° : CTP-SCE-21001		CTP ENVIRONNEMENT		CTP-EC-001	
A		ZAC des gaulhes		10/08/2021		PREMIERE EDITION		DEPARTS PC006 & PC007	
69330 JONAGE		2076 Avenue Henri Schneider		DATE		MODIFICATION		DES.	
CTP		CTP		CTP		CTP		CTP	

1 2 3 4 5 6 7 8 9 10 11 12 13

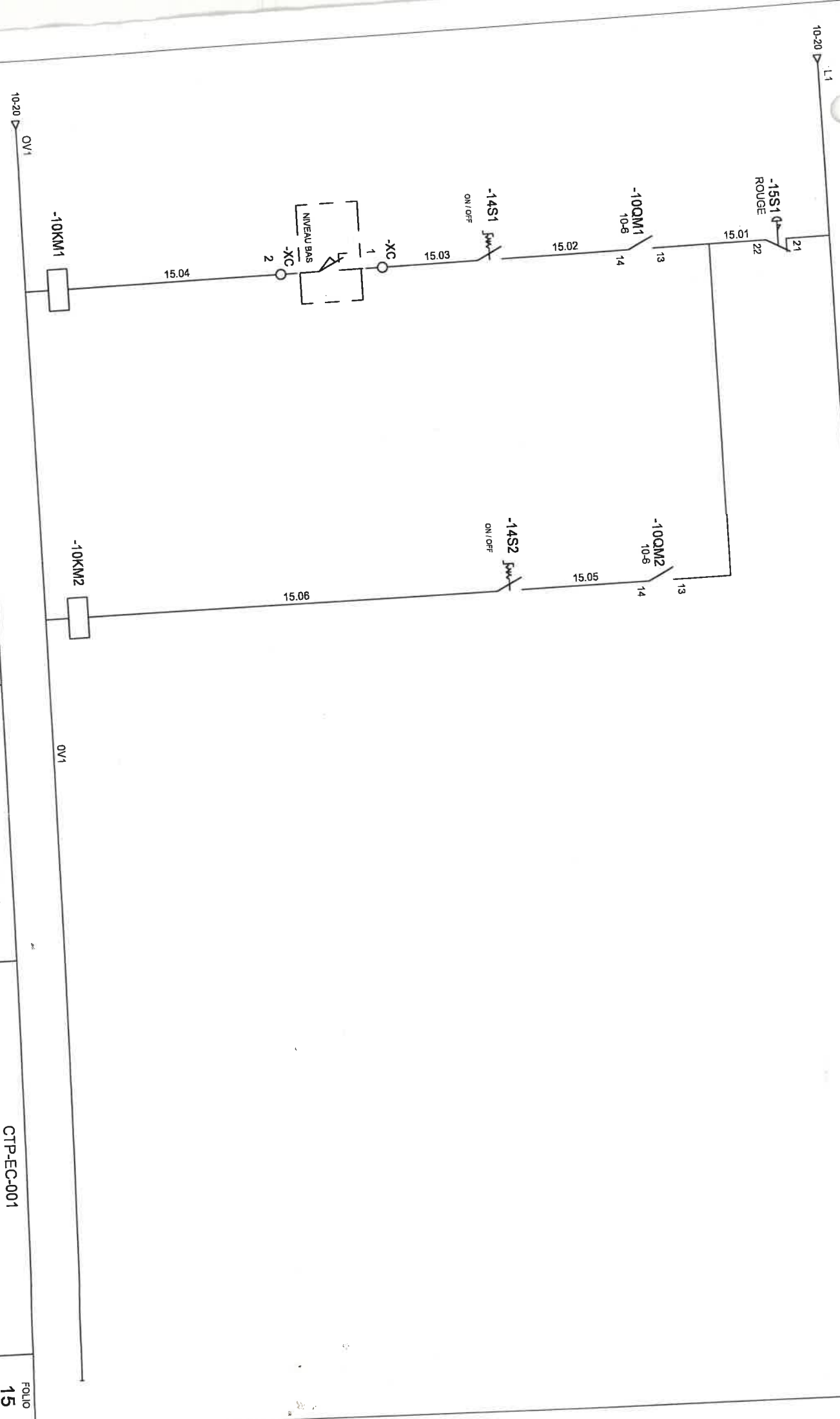

CTP Environnement
 ZAC des gaulines
 2076 Avenue Henri Schneider
 69330 JONAGE

INDEX	DATE	PREMIERE EDITION	MODIFICATION
A	10/06/2021		

Document n° : **CTP-ENVIRONNEMENT**
CTP-SCE-21001

CTP-EC-001
 Commande 24VDC

